



OWNER'S MANUAL

MONITOR SIGNAGE

Please read this manual carefully before operating the your set and retain it for future reference.

32SE3B	32SE3KB
43SE3B	43SE3KB
49SE3B	49SE3KB
55SE3B	55SE3KB
65SE3B	65SE3KB

TABLE OF CONTENTS

3 IMPORTANT PRECAUTIONS

- 3 Electrical Power Related Precautions
- 4 Precautions in installing the Product
- 4 Precautions in Moving the Product
- 5 Precautions in Using/
- 5 Cleaning the Product
- 5 On Disposal (Only, Hg lamp used LCD Monitor)

6 LICENSES

7 ASSEMBLY AND PREPARATION

- 7 Accessories
- 8 Optional Accessories
- 10 Parts and Buttons
- 12 Connecting the Stand
- 13 Connecting the Speakers
- 14 Using the IR Receiver
- 15 Portrait Layout
- 16 Attaching and removing the LG Logo Bracket
- 17 Installing on a Wall

19 REMOTE CONTROL

- 21 Displaying the Device Name Connected to an Input Port
- 21 White Balance Adjust Menu
- 22 Using Picture ID

23 MAKING CONNECTIONS

- 23 Connecting to a PC
- 25 External Device Connection

28 USING THE MONITOR

- 28 Using the Input List
- 28 Adjusting Aspect Ratio

30 ENTERTAINMENT

- 30 Using the Network
- 30 - Connecting to a Network
- 32 - Network Status
- 32 Using the My Media
- 32 - Connecting USB storage devices
- 34 - Browsing Files
- 36 - Viewing Movies
- 39 - Viewing Photos
- 41 - Listening to Music
- 43 - Viewing the Contents List

44 CUSTOMIZING SETTINGS

- 44 Accessing Main Menus
- 45 - PICTURE Settings
- 48 - AUDIO Settings
- 49 - TIME Settings
- 50 - OPTION Settings
- 53 - NETWORK Settings

54 TROUBLESHOOTING

56 PRODUCT SPECIFICATIONS

68 IR CODES

70 TO CONTROL MULTIPLE PRODUCTS

- 70 Connecting the Cable
- 71 RS-232C Configurations
- 71 - 4P Cable
- 71 - RS-232C Cable
- 71 Communication Parameter
- 72 Command Reference List
- 74 Transmission / Receiving Protocol

WARNING: This product contains chemicals known to the State of California to cause cancer and birth defects or other reproductive harm. **Wash hands after handling.**

Important Precautions

Please read these safety precautions carefully before using the product.

WARNING

Failure to follow those warnings may result in death, serious injury or damage to the product or other property.

WARNING

- Indoor Use Only.

Electrical Power Related Precautions

WARNING

- Use only the power cord supplied with the unit or another manufacturer's authorized cord.
 - ▶ Failure to do so may result in fire or electrical shock or damage to the product.
- Use only a properly grounded plug and receptacle.
 - ▶ If you do not you may be electrocuted or injured. Or the product might be damaged.
- Do not use a damaged or loose plug.
 - ▶ This may cause electrical shock or fire.
- Operate the display only from a power source (i.e. voltage) indicated in the product specification.
 - ▶ Otherwise the product can be damaged, fire can occur or you may be electrocuted. If you are not sure what type of power supply you have, consult a certified electrician.
- In the presence of thunder and lightning, never touch the power cord and signal cable because it can be very dangerous.
 - ▶ It can cause electric shock.
- Do not connect several extension cords, electrical appliances or electrical heaters to a single outlet. Use a power bar with a grounding terminal designed for exclusive use with the computer.
 - ▶ A fire can break out due to overheating.
- Do not touch the power plug with wet hands. Additionally, if the cord pin is wet or covered with dust, dry the power plug completely or wipe dust off before plugging in the cord.
 - ▶ You may be electrocuted due to excess moisture.
- If you don't intend to use the product for a long time, unplug the power cable from the product.
 - ▶ Covering dust can cause a fire, or insulation deterioration can cause electric leakage, electric shock or fire.
- Insert the power plug firm so it cannot come loose.
 - ▶ A loose connection can cause fire.
- Hold the plug when pulling out the power cable. Do not pull the plug out by the wire. Do not bend the power cord with excessive force or put heavy objects on the power cord.
 - ▶ The power line can be damaged, which may cause electric shock or fire.
- Do not insert metal or other conductive materials into the product openings. Additionally, do not touch the power cable right after plugging into the wall input terminal.
 - ▶ You may be electrocuted.
- The appliance coupler is used as the disconnect device.
- Please make sure the device is installed near the wall outlet to which it is connected and that the outlet is easily accessible.
- Do not unplug the power cord while the product is in use.
 - ▶ Electrical shock can damage the product.
- As long as this unit is connected to the AC wall outlet, it is not disconnected from the AC power source even if the unit is turned off.

Precautions in installing the Product

WARNING

- Keep away from heat sources like eaters or open flames.
 - ▶ Electrical shock, fire, malfunction or deformation may occur.
- Keep the packing anti-moisture material or vinyl packing out of the reach of children.
 - ▶ Anti-moisture material is harmful if swallowed. If swallowed by mistake, force the patient to vomit and visit the nearest hospital. Additionally, vinyl packing can cause suffocation. Keep it out of the reach of children.
- Do not put heavy objects on the product on sit upon it.
 - ▶ If the product collapses or is dropped, you may be injured. Children must pay particular attention.
- Do not leave the power or signal cable where someone can trip over it.
 - ▶ The passerby can falter, which can cause electrical shock, fire, product breakdown or injury.
- Install the product in a neat and dry place. Do not use near water.
 - ▶ Dust or moisture can cause electrical shock, fire or product damage.
- Do not add accessories that have not been designed for this display.
- If you smell smoke or other odors or hear a strange sound from the product unplug the power cord and contact LG Customer Service.
 - ▶ If you continue to use without taking proper measures, electrical shock or fire can occur.
- If you dropped the product or the case is broken, turn off the product and unplug the power cord.
 - ▶ If you continue to use without taking proper measures, electrical shock or fire can occur. Contact LG Customer Service.
- Do not drop an object on or apply impact to the product. Do not throw any toys or objects at the product.
 - ▶ It can cause injury to humans, problems to the product and damage the display.
- Keep out of reach of children and do not place toys near the product.
- Make sure the product ventilation hole is not blocked. Install the product more than 10cm from the wall.
 - ▶ If you install the product too close to the wall, it may be deformed or fire can break out due to internal heat build-up.
- Do not cover the product with cloth or other material (eg. plastic) while plugged in.
 - ▶ The product can be deformed or fire can break out due to internal overheating.
- Place the product on a flat and stable surface that is large enough to support the product.
 - ▶ If the product is dropped, you may be injured or the product may be broken.
- Install the product where no Electromagnetic Interference occurs.
- Keep the product away from direct sunlight.
 - ▶ The product can be damaged.

- Do not place the product on the floor.
 - ▶ Small Children and others may trip over it.
- Do not install this product on a wall if it could be exposed to oil or oil mist.
 - ▶ This may damage the product and cause it to fall.
- For displays with glossy bezels the user should consider the placement of the display as the bezel may cause disturbing reflections from surrounding light and bright surfaces.

Precautions in Moving the Product

WARNING

- Make sure to turn off the product.
 - ▶ You may be electrocuted or the product can be damaged.
- Make sure to remove all cables before moving the product.
 - ▶ You may be electrocuted or the product can be damaged.
- When lifting or moving the product, do not hold it upside down while holding only the stand.
 - ▶ This may cause the product to fall resulting in damage or injury.
- Do not shock the product when moving it.
 - ▶ You may be electrocuted or the product can be damaged.
- Make sure the panel faces forward and hold it with both hands to move.
 - ▶ If you drop the product, the damaged product can cause electric shock or fire.
- Do not place the product face down.
 - ▶ This may damage the TFT-LCD screen.

Precautions in Using/ Cleaning the Product

⚠ WARNING

- Do not attempt to disassemble, repair or modify the product yourself.
 - ▶ Fire or electric shock can occur.
 - ▶ Contact LG Customer Service for repair.
- When cleaning the product, unplug the power cord and scrub gently with a soft cloth to prevent scratching. Do not clean with a wet cloth or spray water or other liquids directly onto the product. An electric shock may occur. (Do not use chemicals such as benzene, paint thinners or alcohol)
- Keep the product away from water.
 - ▶ Fire or electric shock accident can occur.
- Avoid high temperatures and humidity.
- Do not put or store flammable substances near the product.
 - ▶ There is a danger of explosion or fire.
- Keep the product clean at all times.
- Take a comfortable and natural position when working with the product.
- Take a regular break when working with the product for a long time.
- Do not press on the panel with a hand or sharp object such as nail, pencil or pen, or make a scratch on it.
- Keep proper distance from the product and rest from time-to-time.
 - ▶ Your vision may be impaired if you look at the product too closely or for too long.
- Set the appropriate resolution by referring to the User's Guide.
- Keep small accessories out of the reach of children.
- Displaying a still image for long time on the monitor may leave persistent image or stain on the monitor screen. To avoid this problem, use a screen saver and power off when this product is not used. Persistent image or stain caused by long time usage are not covered by the warranty on this product.
- Do not use products using high voltage around the Monitor. (ex. Electrical Swatter)
 - ▶ Monitor may have malfunction as its electrical shock.
- Spray water onto a soft cloth 2 to 4 times, and use it to clean the front frame; wipe in one direction only. Too much moisture may cause staining.

On Disposal (Only, Hg lamp used LCD Monitor)

- The fluorescent lamp used in this product contains a small amount of mercury.
- Do not dispose of this product with general household waste.
- Disposal of this product must be carried out in accordance to the regulations of your local authority.

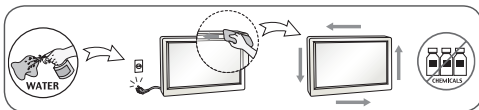

LICENSES

Supported licenses may differ by model. For more information of the licenses, visit www.lg.com.



The terms HDMI and HDMI High-Definition Multimedia Interface, and the HDMI logo are trademarks or registered trademarks of HDMI Licensing LLC in the United States and other countries.



This DivX Certified® device has passed rigorous testing to ensure it plays DivX® video.

To play purchased DivX movies, first register your device at vod.divx.com. Find your registration code in the DivX VOD section of your device setup menu.

DivX Certified® to play DivX® video up to HD 1080p, including premium content.

DivX®, DivX Certified® and associated logos are trademarks of DivX, LLC and are used under license.

Covered by one or more of the following U.S. patents:

7,295,673; 7,460,668; 7,515,710; 7,519,274.



Manufactured under license from Dolby Laboratories. Dolby and the double-D symbol are trademarks of Dolby Laboratories.

ASSEMBLY AND PREPARATION

Accessories

Check your product box for the following items. If there are any missing accessories, contact the local dealer where you purchased your product. The illustrations in this manual may differ from the actual product and accessories.

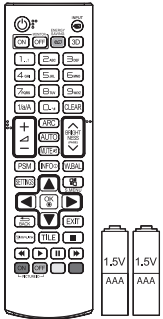

Remote Control,
Batteries (AAA) 2 EA

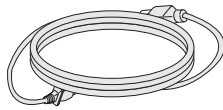

Power Cord

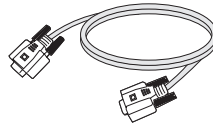

D-sub 15-pin Signal
Cable



Card and the Letter of
Warranty

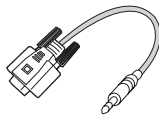

RS-232C Gender

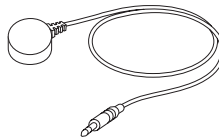

IR Receiver



CAUTION

- Always use genuine components to ensure safety and product performance.
- The product warranty will not cover damage or injury caused by the use of counterfeit components.



NOTE

- The accessories provided with your product may vary depending on the model or region.
- Product specifications or contents in this manual may be changed without prior notice due to upgrade of product functions.
- SuperSign Software & Manual
 - Downloading from the LG Electronics website.
 - Visit the LG Electronics website (www.lgcommercial.com/supersign) and download the latest software for your model.

Optional Accessories

Without prior notice, optional accessories are subject to change to improve the performance of the product, and new accessories may be added. The illustrations in this manual may differ from the actual product and accessories.

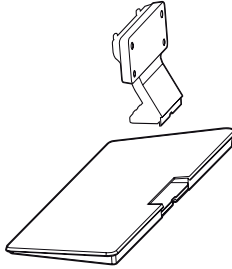

Stand

ST-322T	32SE3*
ST-432T	43SE3*
ST-492T	49SE3*/55SE3*
ST-652T	65SE3*



Stand Spacers

32SE3*	-
43SE3*	2 EA
49SE3*	
55SE3*	
65SE3*	



Screws

Diameter 4.0 mm x Pitch 0.7 mm

Model	Length (including spring washer)	Quantity
32SE3*	10 mm	6 EA
43SE3*	14 mm	8 EA
49SE3*	14 mm	8 EA
55SE3*	14 mm	8 EA
65SE3*	16 mm	8 EA

Stand kit

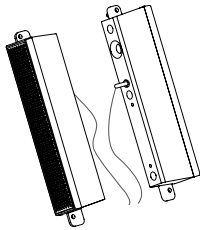

Speakers SP-5000



**Cable holder/
Cable Tie**



Screws

Diameter 4.0 mm x Pitch 0.7 mm x Length 8 mm (including spring washer)

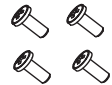

Screws

Diameter 4.0 mm x Pitch 1.6 mm x Length 10 mm

Speaker kit

(Only for **SE3B model)

NOTE

- Cable holder/cable tie may not be available in some areas or for some models.
- Optional accessories are available for some models. If necessary, please purchase them separately.

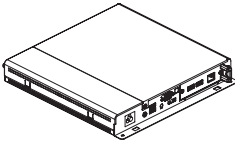

**Media Player
MP500/MP700**



Screws



**CD (Owner's Manual)/
Cards**

Media Player kit

(It may not be supported depending on the model.)

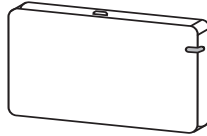

AN-WF500

Wi-Fi Dongle kit

! NOTE

- Optional accessories are available for some models. If necessary, please purchase them separately.

Parts and Buttons

- The image may be different according to the model

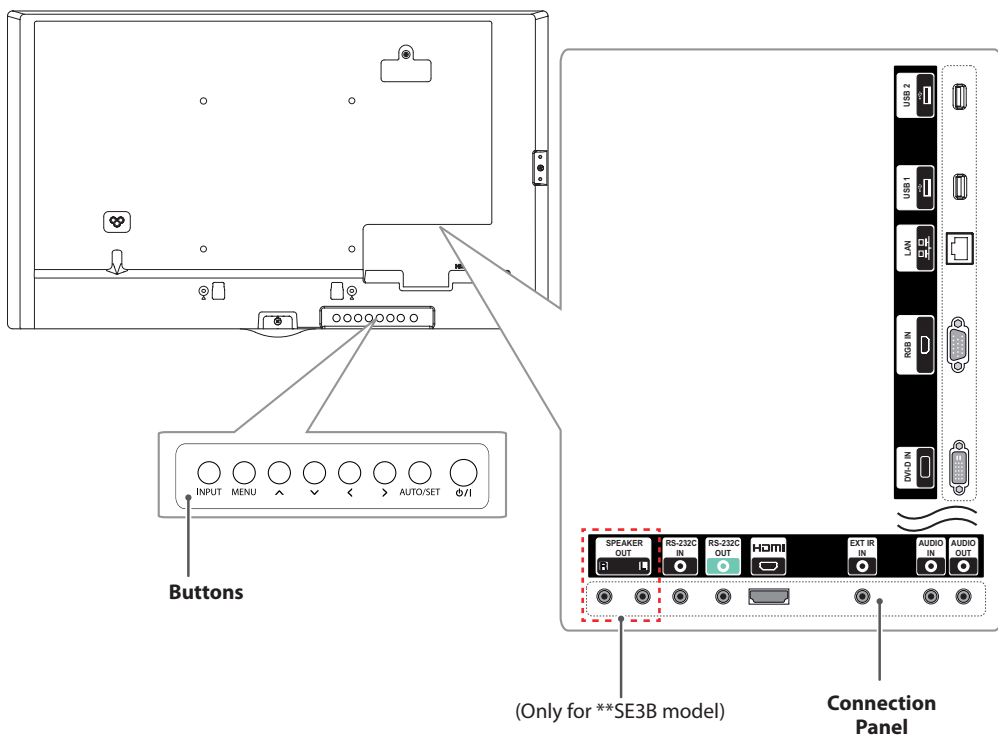
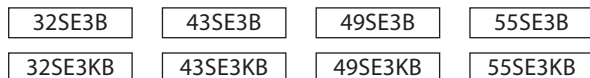

Buttons	Description
INPUT	Changes the input source.
MENU	Accesses the main menus, or saves your input and exits the menus.
▲ ▼	Adjust the up and down.
◀ ▶	Moves left and right.
AUTO/SET	Displays the current signal and mode.
⏻ / I	Turns the power on or off.

65SE3B

65SE3KB

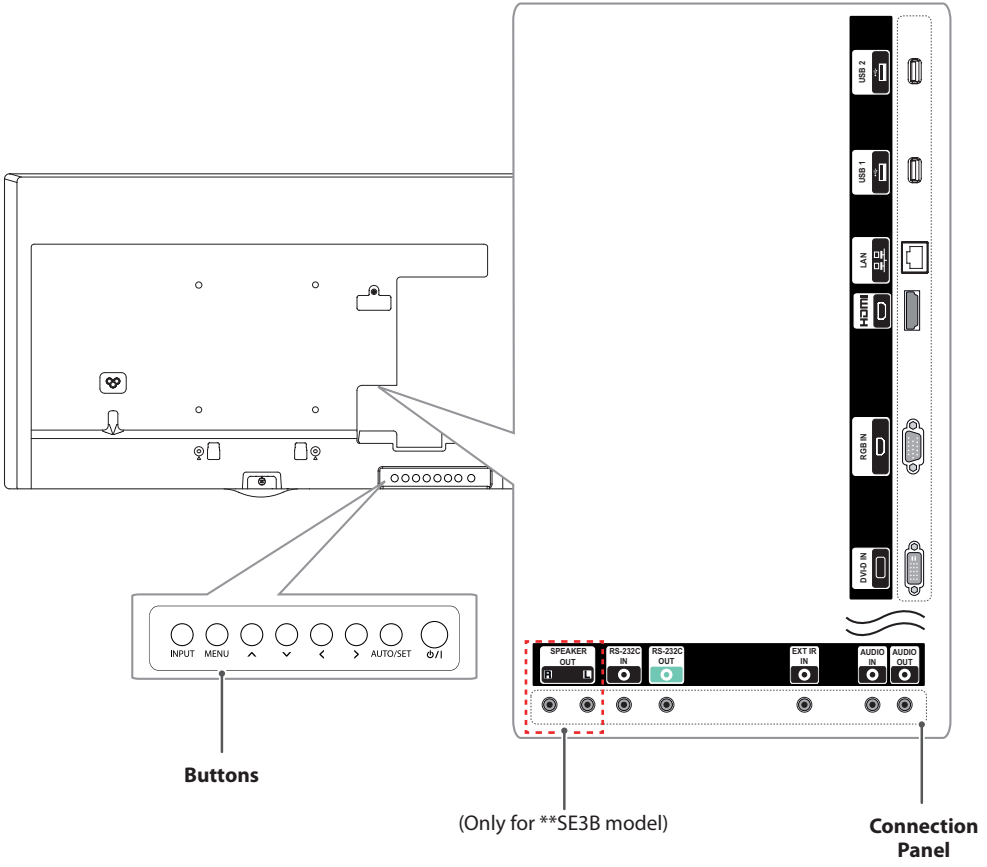

Buttons	Description
INPUT	Changes the input source.
MENU	Accesses the main menus, or saves your input and exits the menus.
^ v	Adjust the up and down.
< >	Moves left and right.
AUTO/SET	Displays the current signal and mode.
⏻ /	Turns the power on or off.

Connecting the Stand

- For certain models only.
- The image may be different according to the model

32SE3*

- 1 Place a soft cloth on the table and place the product with the screen facing downward.

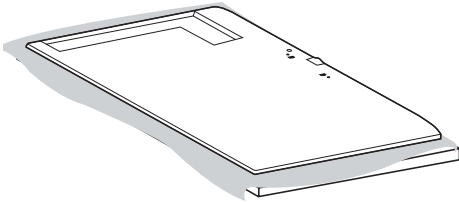

- 2 Use the screws to secure the stand to the back of the product as shown below.

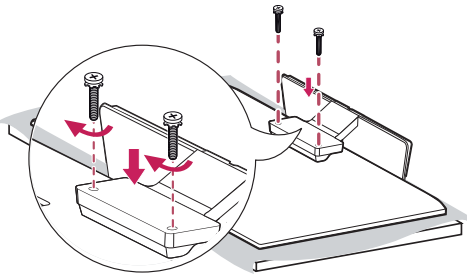

43SE3*

49SE3*

55SE3*

65SE3*

- 1 Place a soft cloth on the table and place the product with the screen facing downward.

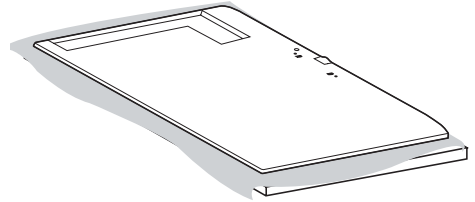

- 2 Tighten stand spacers on the back of the product as shown below.

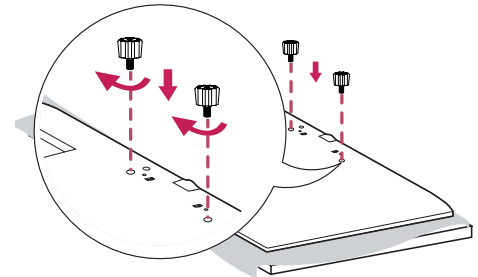

- 3 Use the screws to secure the stand to the back of the product as shown below.

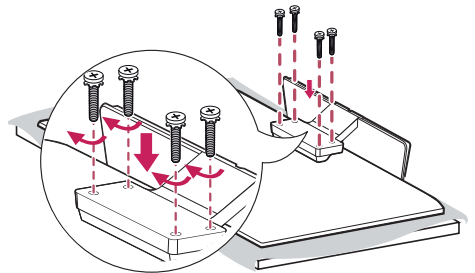

Connecting the Speakers

- For certain models only. (Only for **SE3B model)
- The image may be different according to the model.

32SE3B

- 1 Connect an input signal cable before installing the speakers.

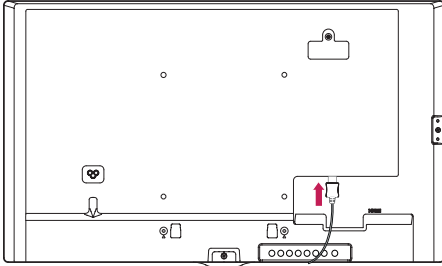

- 2 Mount the speakers by using screws as shown below. Make sure the power cable is disconnected before making a connection.

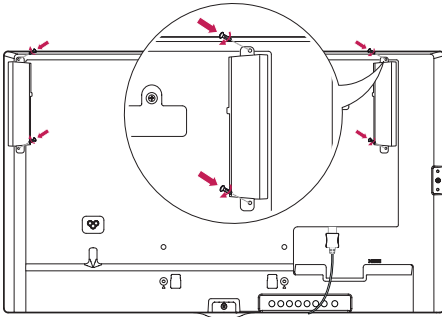

- 3 Then connect the speaker cable. After installing your speakers, use holders and cable ties to organize the speaker cables.

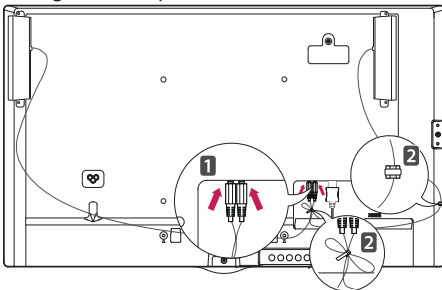

43SE3B

49SE3B

55SE3B

65SE3B

- 1 Connect an input signal cable before installing the speakers.

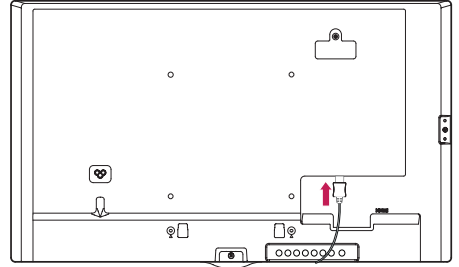

- 2 Mount the speakers by using screws as shown below. Make sure the power cable is disconnected before making a connection.

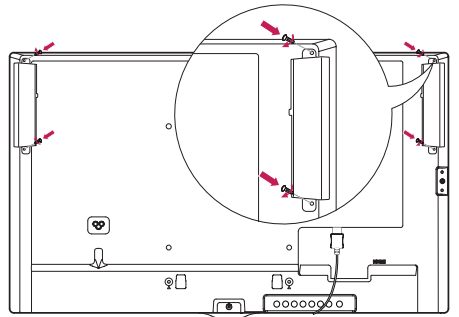

- 3 Then connect the speaker cable. After installing your speakers, use holders and cable ties to organize the speaker cables.

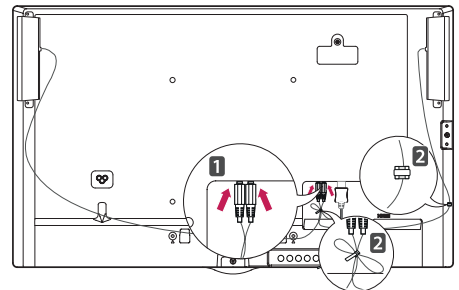

! NOTE

- Please turn off the power before removing the cable. Connecting or removing the speaker cable while turned on may result in no sound.

Using the IR Receiver

- The image may be different according to the model.

This allows a remote control sensor to be placed in a custom location. Then that display can control other displays via an RS-232C cable. Install the IR receiver towards the front of the set.

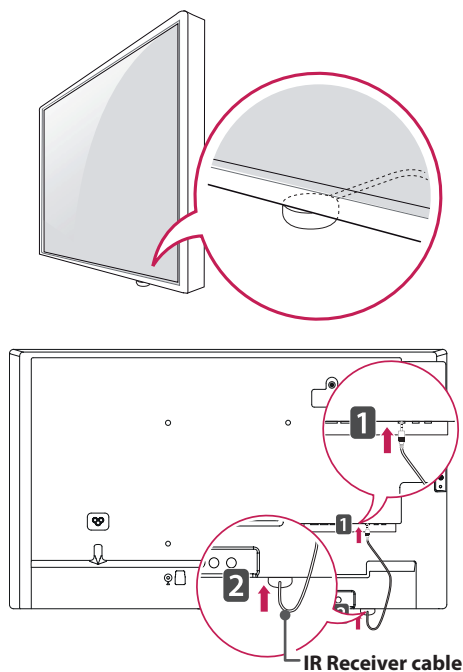

! NOTE

- When you see from the back of the set, if the IR receiver cable does not face front, the signal reception range may shorten.
- The IR receiver is made with a magnet. It is detachable at the bottom (typical installation) or back (wall installation) of the set.
- Make sure that you unplug the power cord before connecting or removing the IR Receiver.

Portrait Layout

When installing in a portrait layout, rotate the monitor counterclockwise 90 degrees (when facing the screen).

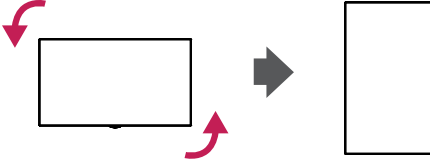

Using Kensington Lock

(This is not available for all models.)

The Kensington security system connector is located at the back of the monitor. For more information on installation and use of this system, refer to the manual provided with the Kensington security system or visit <http://www.kensington.com>.

Connect the Kensington security system cable between the monitor and a table.

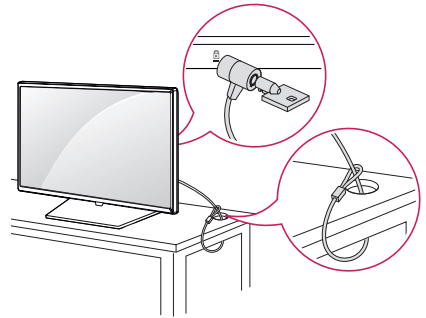

! NOTE

- The Kensington security system is optional. You can obtain additional accessories from most electronics retail stores.

Attaching and removing the LG Logo Bracket

- For certain models only.
- The image may be different according to the model.

Removing the LG Logo

- 1 Lay a clean cloth on the floor, and then put the monitor on it with the screen face down. Using a screwdriver, remove the screw that secures the LG Logo Bracket to the bottom rear of the monitor.

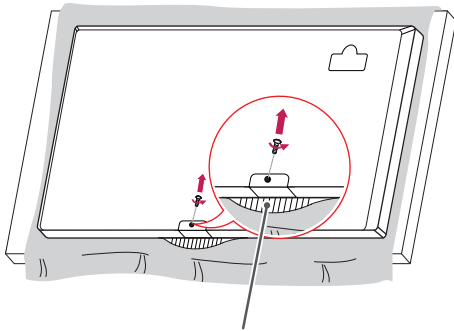

LG Logo Bracket

- 2 After removing the screw, remove the LG Logo. When re-attaching the LG Logo, repeat the process in reverse order.

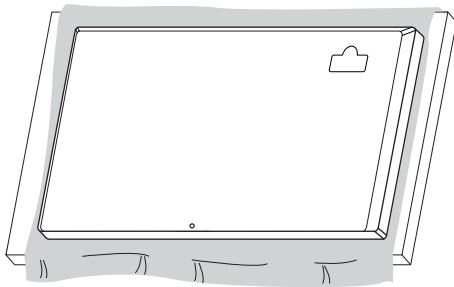

Attaching the LG Logo on the right side

- 1 Lay a clean cloth on the floor, and then put the monitor on it with the screen face down. Using a screwdriver, remove the screw that secures the LG Logo Bracket to the bottom rear of the monitor.

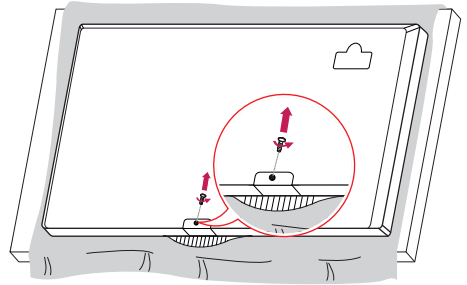

- 2 After removing the screw, remove the LG Logo. Attach the LG Logo Bracket with a screw, aligning it with the hole on the right side.

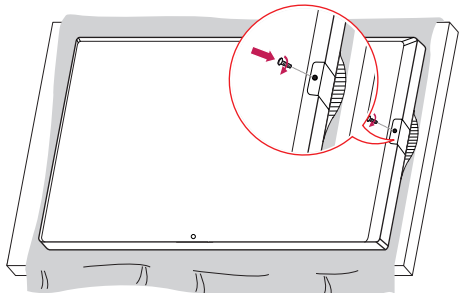

Installing on a Wall

For proper ventilation, allow a clearance of 10 cm on each side and from the wall. Detailed installation instructions are available from your dealer, see the optional Tilt Wall Mounting Bracket Installation and Setup Guide.

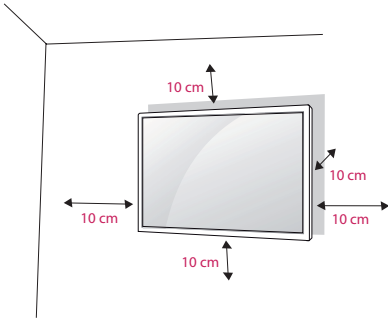

To install your monitor on a wall, attach a wall mounting bracket (optional part) to the back of the monitor.

Make sure that the wall mounting bracket is securely fixed to the monitor and to the wall.

- 1 Use only screws and wall mounting brackets that conform to VESA standards.
- 2 Screws which are longer than standard length may damage the inside of the monitor.
- 3 A non-VESA standard screw may damage the product and cause the monitor to fall. LG Electronics is not liable for any accidents related to the use of non-standard screws.
- 4 Please use VESA standard as below.
 - 785 mm and above

* Fixing screws: Diameter 6.0 mm x Pitch 1.0 mm x Length 12 mm

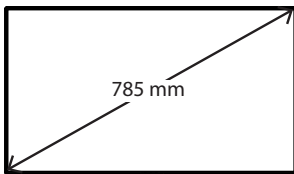

CAUTION

- Disconnect the power cord before moving or installing the monitor to avoid risk of electric shock.
- If you install the monitor on a ceiling or slanted wall, it may fall and result in injury. Use an authorized LG wall mount and contact your local dealer or qualified personnel to assist with the installation.
- Do not over tighten the screws as this may damage the monitor and void your warranty.
- Use only screws and wall mounting brackets that meet the VESA standard. Any damage or injuries caused by misuse or use of improper accessories are not covered by the warranty.
- To prevent injury, this apparatus must be securely attached to the wall in accordance with the installation instructions. (This pertains only to Australia and New Zealand.)

NOTE

- The wall mount kit includes the installation guide and all necessary parts.
- The wall mounting bracket is optional. You can obtain additional accessories from your local dealer.
- The length of screws required may differ depending on the wall mount. Be sure to use the correct length.
- For more information, please refer to the guide provided with the wall mount.
- The warranty will not cover any damages caused by using the product in an excessively dusty environment.

Securing the monitor to a wall (optional)

Procedure may differ depending on the model.

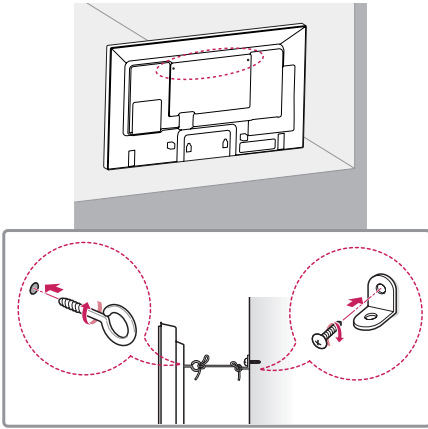

- 1 Insert and tighten the eyebolts, or brackets and bolts on the back of the monitor.
 - If there are already bolts inserted in the eyebolts' position, remove the other bolts first.
- 2 Mount the wall brackets with the bolts to the wall. Match the location of the wall bracket and the eyebolts on the rear of the monitor.
- 3 Connect the eyebolts and wall brackets tightly with a sturdy cord. Make sure the securing cord is horizontal with the flat surface.

CAUTION

- Make sure that children do not climb on or hang from the monitor.

NOTE

- Use a platform or cabinet that is large and strong enough to support the monitor securely.
- Brackets, bolts, and cords are sold separately. You can obtain additional accessories from your local retail store.
- The illustration shows a general example of installation and may look different from the actual product.

WARNING

- If the monitor is not positioned in a sufficiently stable location, there is a danger that it will fall. Many injuries, particularly to children, can be avoided by taking simple precautions such as:
 - » Using cabinets or stands recommended by the manufacturer.
 - » Only using furniture that can safely support the monitor.
 - » Ensuring the monitor is not overhanging the edge of the supporting furniture.
 - » Not placing the monitor on tall furniture (for example, cupboards or bookcases) without anchoring both the furniture and the monitor to a suitable support.
 - » Not placing cloth or other materials between the monitor and supporting furniture.
 - » Educating children about the dangers of climbing on furniture to reach the monitor or its controls.

REMOTE CONTROL

The descriptions in this manual are based on the buttons on the remote control. Please read this manual carefully to use the monitor correctly.

To install batteries, open the battery cover, place batteries (1.5 V AAA) matching ⊕ and ⊖ terminals to the labels inside the compartment, and close the battery cover.

To remove the batteries, perform the installation actions in reverse. The illustrations may differ from the actual accessories.



CAUTION

- Do not mix old and new batteries, as this may damage the remote control.
- Be sure to point the remote control toward the remote control sensor on the monitor.

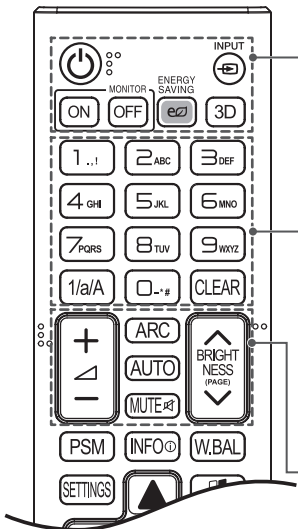
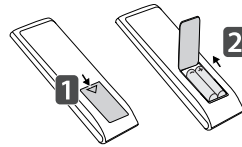

⏻ (POWER) Turns the monitor on or off.
MONITOR ON Turns the monitor on.
MONITOR OFF Turns the monitor off.
ENERGY SAVING (e) Reduces power consumption by adjusting peak screen brightness.
INPUT Selects the input mode.
3D Used for viewing 3D videos. (This model does not support this.)

1/a/A Toggles between numerical and alphabetical.
 (Depending upon the model, this feature may not be supported.)
Number and Alphabet buttons
 Enters numerical or alphabetical characters depending upon the setting.
 (Depending upon the model, this feature may not be supported.)
CLEAR Deletes the entered numerical or alphabetical character.
 (Depending upon the model, this feature may not be supported.)

Volume Up/Down Button Adjusts the volume.
ARC Selects the Aspect Ratio mode.
AUTO Automatically adjusts picture position and minimizes image instability (available for RGB input only). (Depending upon the model, this feature may not be supported.)
MUTE Mutes all sounds.
BRIGHTNESS Adjust the brightness by pressing the Up and Down buttons on the remote control. In USB mode, the OSD menu has the Page function to move to the next file list. (Depending upon the model, this feature may not be supported.)

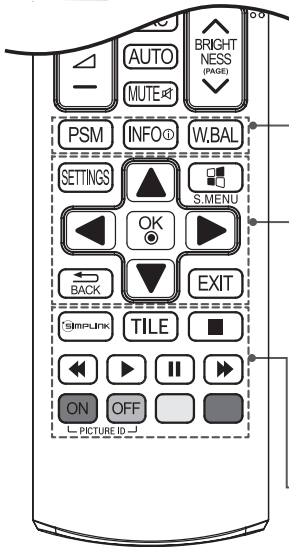

- PSM** Selects the Picture Mode.
- INFO** ⓘ Views the information of the currently program and the screen.
- W.BAL** Enters the White Balance menu.
- SETTINGS** Accesses the main menus or saves your input and exit menus.
- S.MENU** SuperSign menu key (Depending upon the model, this feature may not be supported.)
- Navigation Buttons** Scrolls through menus or options.
- OK** Selects menus or options and confirms your input.
- BACK** Allows you to move back one step in the user interaction function.
- EXIT** Quit all OSD tasks and applications.
- SIMPLINK** Allows you to control various multimedia devices to enjoy multimedia simply by using the remote control through the SimpLink menu. (Depending upon the model, this feature may not be supported.)
- TILE** Selects the TILE Mode.
- PICTURE ID ON/OFF** When the Picture ID number matches the Set ID number, you can control whichever monitor you want in multi-display format.
- USB Menu Control Buttons** Controls media playback.

Displaying the Device Name Connected to an Input Port

Display which devices are connected to which external input ports.

- 1 Access the Input list screen and press the red (input label) button on the remote control.
- 2 You can assign an input label for every input except USB.

NOTE

- External inputs supported : HDMI, DVI-D
- Labels available : PC, DTV
- The input labels are displayed on the Input Label screen or at the top left of the screen when you change the external input setting.
- For DTV/PC-compatible signals, such as 1080p 60 Hz, the screen settings may change according to the input label. The Just Scan option is available if a PC is connected as an external device.

White Balance Adjust Menu

Press the W.BAL button on the remote control.

- **R-Gain** : Adjusts the level of red. The higher the number, the redder the set. Decrease the number if the screen looks too red.
- **G-Gain** : Adjusts the level of green. The higher the number, the greener the set. Decrease the number if the screen looks too green.
- **B-Gain** : Adjusts the level of blue. The higher the number, the bluer the set. Decrease the number if the screen looks too blue.
- **Backlight** : Adjusts the brightness. The higher the number, the brighter the set. This works in the same way as the backlight of the user menu.
- **Reset** : Resets the white balance value to the factory settings.

Using Picture ID

Picture ID is used to change the settings of a specific display using a single IR receiver for multi-vision. The set receiving the IR signal communicates with another set via an RS-232C connection. Each set is identified by a Set ID. If you assign the Picture ID using the remote control, only displays with the same Picture ID and Set ID can be controlled remotely.

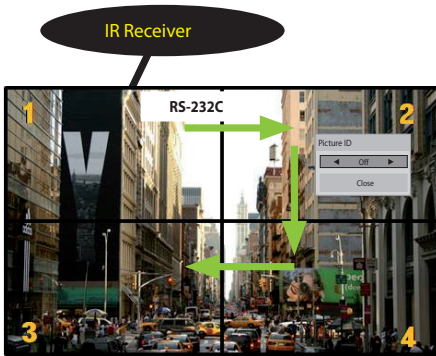

2X2 Multi-Vision

Set IDs are assigned as shown in the picture.

- 1 Press the red ON button on the remote control to assign the Picture ID.
 - 2 To change the Picture ID, press the ON button, or the left and right arrow buttons continuously. Assign the ID you want.
- If you assign the Set ID to each set with multi-vision, and then assign the Picture ID using the red button on the remote control, the key command is displayed for the set with the same Set ID and Picture ID. A set with different Set IDs and Picture IDs cannot be controlled by IR signals.

! NOTE

- For example, if the Picture ID is assigned to 2, the upper right display (Set ID: 2) can be controlled by IR signals.
- For each set, you can change the settings for the PICTURE, AUDIO, TIME, NETWORK and MY MEDIA menus or the hot keys on the remote control.
- If you press the green OFF button for Picture IDs, the Picture IDs for all sets are turned off. If you then press any button on the remote control, all sets will start working again.
- Picture ID will be disabled while using the MY MEDIA menu.

MAKING CONNECTIONS

You can connect various external devices to your monitor. Change the input mode and select the external device you want to connect.

For more information about external device connections, see the user manual provided with each device.

Connecting to a PC

The illustrations may differ from the actual accessories. Some of the cables are not provided.

This monitor supports the Plug & Play* feature.

* Plug & Play: a feature that enables a PC to recognize devices attached by the user without device configuration or user intervention when powering up.

- 32SE3*
- 43SE3*
- 49SE3*
- 55SE3*

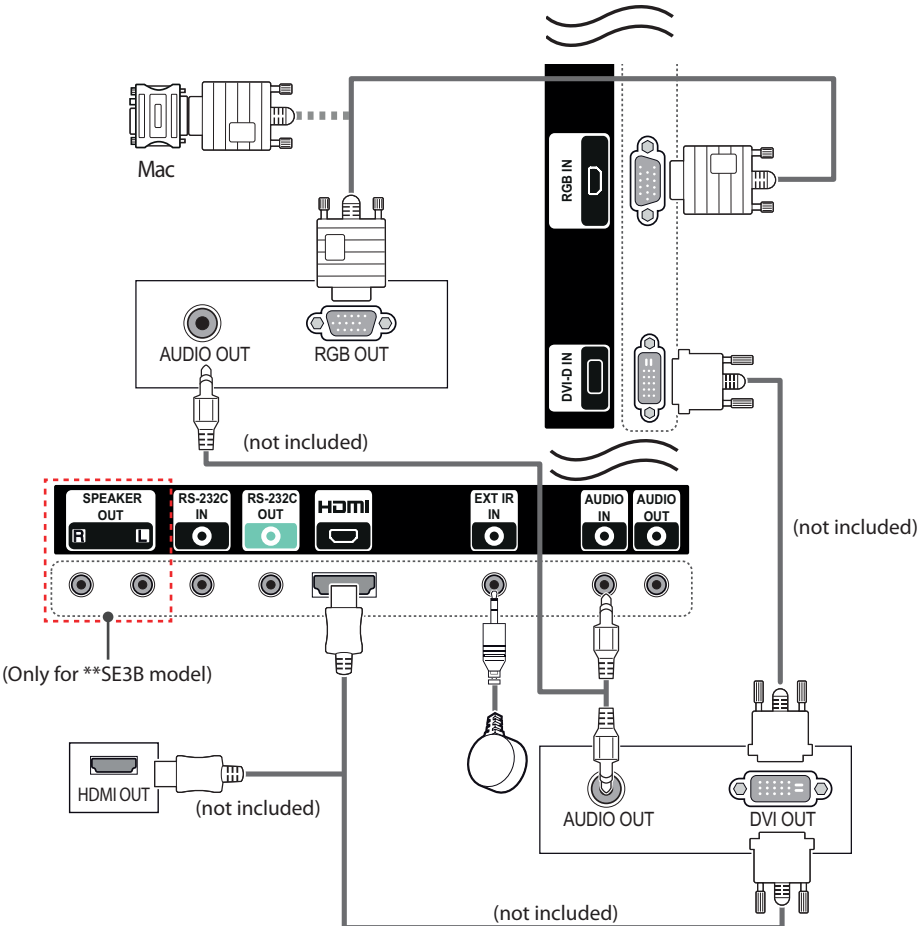

65SE3*

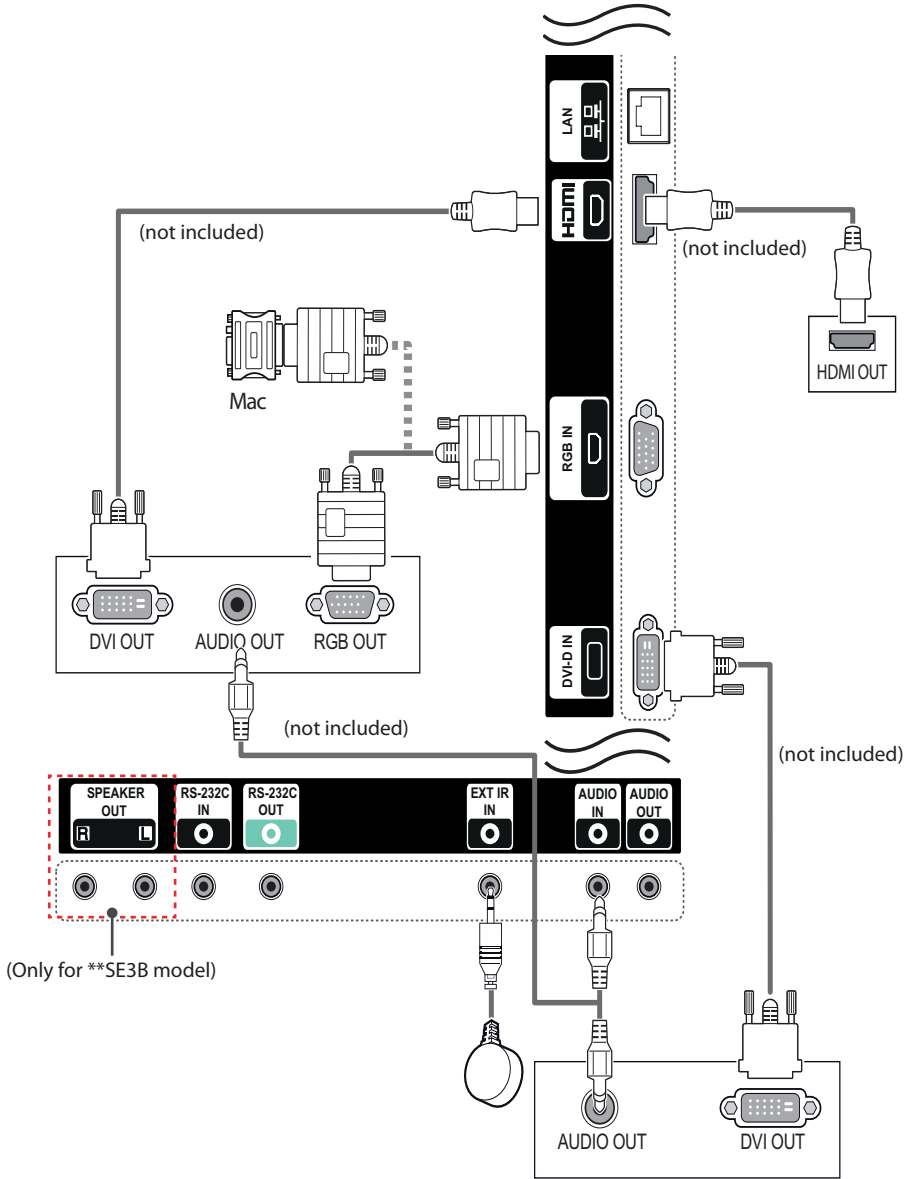

External Device Connection

Connect a HD receiver, DVD, or VCR player to the monitor and select an appropriate input mode.

The illustrations may differ from the actual accessories. Some of the cables are not provided. For the best picture and sound quality, connecting external devices to your monitor using HDMI cables is recommended.

- 32SE3*
- 43SE3*
- 49SE3*
- 55SE3*

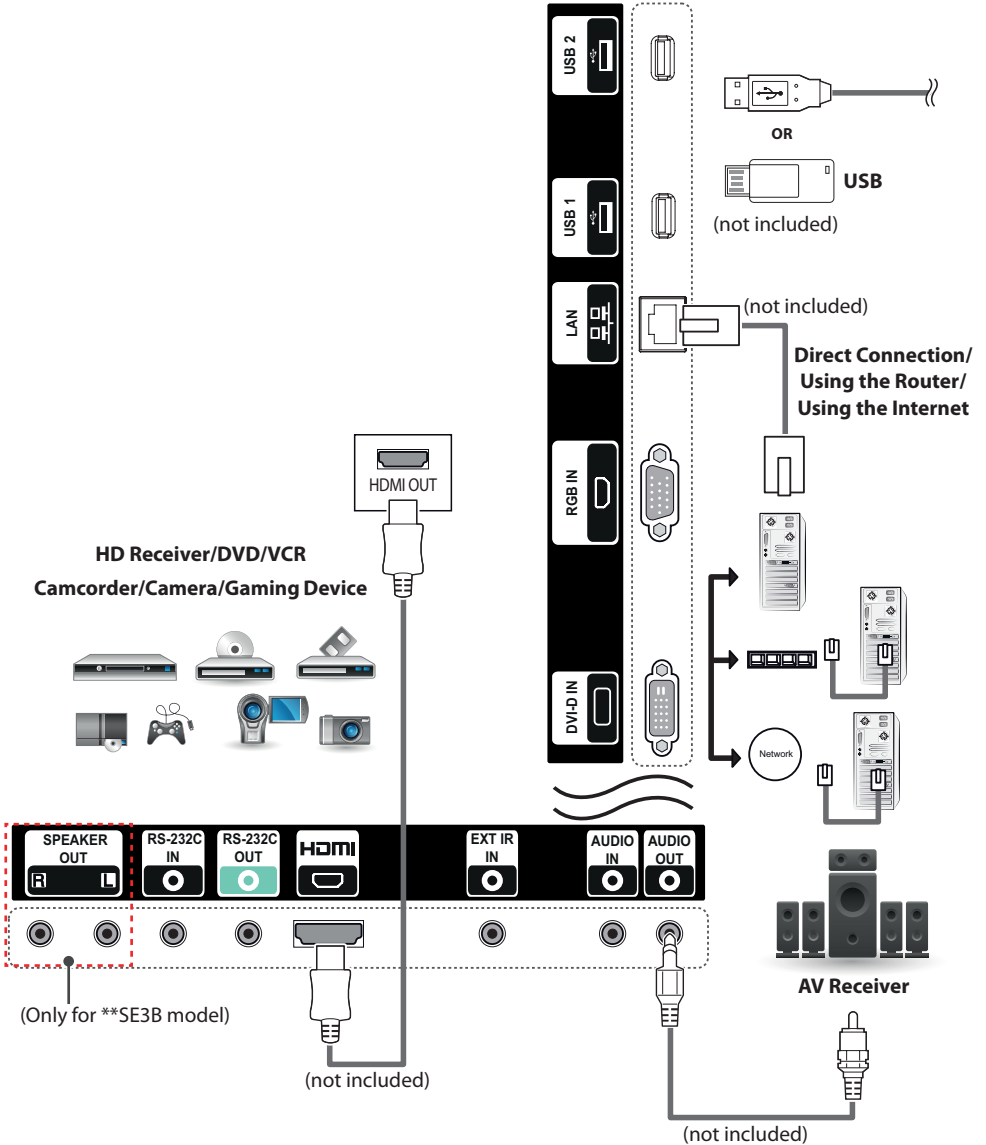

65SE3*

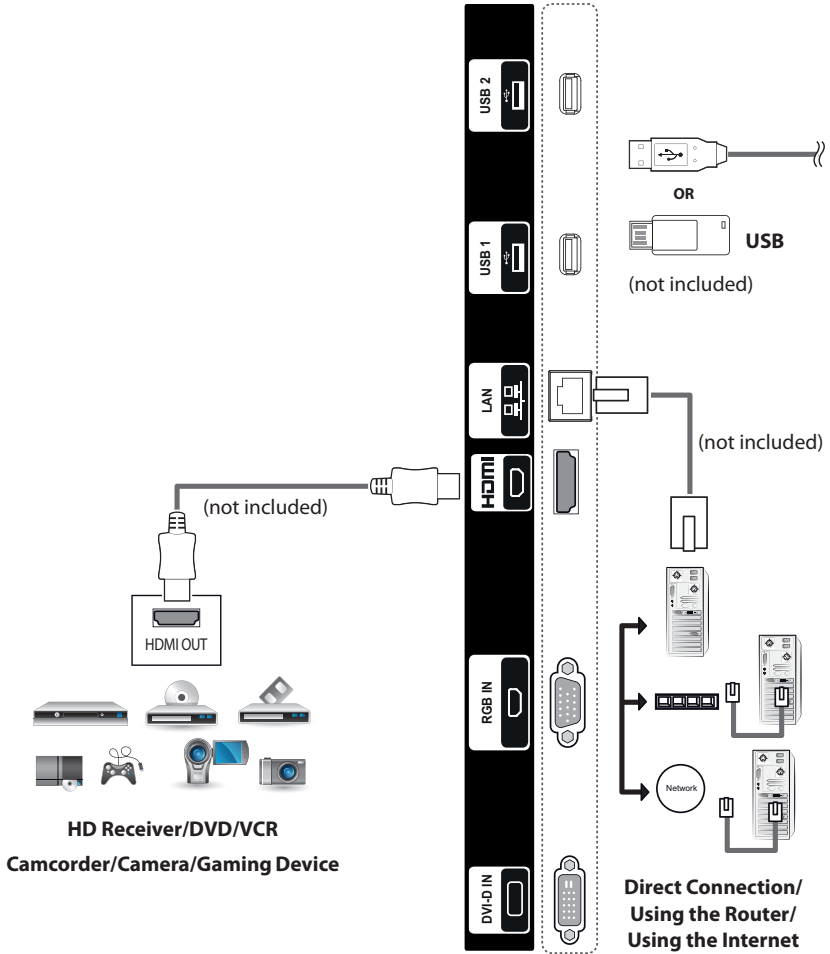

(Only for **SE3B model)

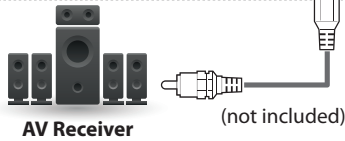

! NOTE

- The monitor set with the HDMI connection for the best image quality.
- To comply with the specifications of the product, use a shielded interface cable with ferrite core, such as a D-sub 15-pin cable and DVI-D/HDMI cable.
- If you turn the monitor set on when the set becomes cold, the screen may flicker. This is normal.
- Some red, green, or blue spots may appear on the screen. This is normal.
- To minimize the impact of electromagnetic waves, secure the cables with cable ties.
- Use a High Speed HDMI®/™ Cable.
- If you want to use HDMI-PC mode, you must set the input label to PC mode.
- When HDMI PC is used, a compatibility problem could occur.
- Use a certified cable with the HDMI logo attached. If you do not use a certified HDMI cable, the screen may not display or a connection error may occur.
- Recommended HDMI cable types
 - High-Speed HDMI®/™ Cable
 - High-Speed HDMI®/™ Cable with Ethernet

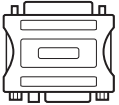

- Use the standard Macintosh adapter since an incompatible adapter is available in the market. (Different signaling system)
- Apple computers may require an adapter to connect to this monitor. Call or visit their web site for more information.

! CAUTION

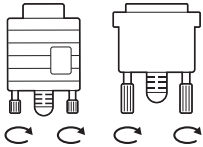

- Connect the signal input cable and tighten it by turning the screws clockwise.
 - Do not press the screen with your finger for a long time as this may result in temporary distortion on the screen.
 - Avoid displaying a fixed image on the screen for a long period of time to prevent image burn. Use a screensaver if possible.
- If using a DP to HDMI dongle, make sure to use a dongle certified by the graphics card manufacturer.
 - When connecting to multi-channel ports of a graphics card, make sure to use DP to HDMI dongles of the same model.

USING THE MONITOR

Using the Input List

- 1 Press **INPUT** to access the **Input List**.
- 2 Press the navigation buttons to scroll to one of the input mode and press **OK**.
 - **RGB** : View a PC display on the screen.
 - **HDMI** : Watch contents in a PC, DVD of digital set-top box other high definition devices.
 - **DVI-D** : Displays multimedia contents on your PC, DVD and other HD devices.
 - **USB** : Plays the multimedia file saved in the USB.

Adjusting Aspect Ratio

Resize the image to view the image at its optimal size by pressing ARC while you are watching monitor set.

MODE \ Aspect Ratio	RGB	HDMI		DVI-D	
	PC	DTV	PC	DTV	PC
16:9	o	o	o	o	o
Just Scan	x	o	x	o	x
Set By Program	x	o	x	o	x
4:3	o	o	o	o	o
Zoom	x	o	x	o	x
Cinema Zoom 1	x	o	x	o	x

NOTE

- You can also change the image size by accessing the main menus.
- The Just Scan mode operates when a video signal has resolution of 720p or higher.

CAUTION

- If a fixed image displays on the screen for a long period of time, it will be imprinted and become a permanent disfigurement on the screen. This is image burn or burn-in and not covered by the warranty.
- If you don't use your monitor, turn the power off or set a screen saver program from the PC or the system to prevent image retention.
- If the aspect ratio is set to 4:3 for a long period of time, image burn may occur on the letterboxed area of the screen.

- **16:9** This selection will allow you to adjust the picture horizontally, in linear proportion, to fill the entire screen (useful for viewing 4:3 formatted DVDs).
- **Just Scan** This Selection will allow you view the picture of best quality without loss of original picture in high resolution image. Note: If there is noise in original Picture, You can see the noise at the edge.
- **Set By Program** Depending on the input signal, screen aspect ratio changes to 4:3 or 16:9.
- **4:3** This selection will allow you to view a picture with an original 4:3 aspect ratio, black bars will appear on both the left and right of the screen.
- **Zoom** This selection will allow you to view the picture without any alteration, while filling the entire screen. However, the top and bottom of the picture will be cropped.
- **Cinema Zoom1** Choose Cinema Zoom when you want to enlarge the picture in correct proportion.
Note: When enlarging or reducing the picture, the image may become distorted.

ENTERTAINMENT

Using the Network

Connecting to a Network

For wired network connections, connect the display to a local area network (LAN) via the LAN port as shown on the following diagram. Then, set up the network settings. For wireless network connections, connect the Wi-Fi USB module to the USB port. Then, set up the network settings.

After making a physical connection, a small number of home networks may require the display network settings to be adjusted. For most home networks, the display will connect to automatically without any adjustments.

For detail information, contact your internet provider or router manual.

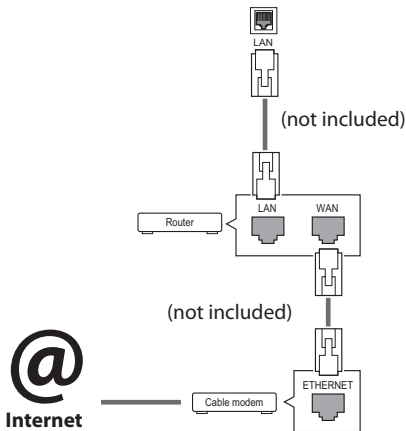

To set up the network settings: (Even if your display has already connected automatically, running setup again will not harm anything),

Connecting to a wired network

- 1 Press **SETTINGS** to access the main menus.
- 2 Press the navigation buttons to scroll to **NETWORK** and press **OK**.
- 3 Press the navigation buttons to select **Network Setting** and press **OK**.
- 4 If you already set network setting, select **Resetting**. The new connection settings resets the current network settings.
- 5 Select **IP Auto Setting** or **IP Manual Setting**.
 - **IP Manual Setting**
press the navigation and number buttons. IP addresses will need to be input manually.
 - **IP Auto Setting**
Select this if there is a DHCP server (Router) on the local area network (LAN) via wired connection, the display will automatically be allocated an IP address. If you're using a broadband router or broadband modem that has a DHCP (Dynamic Host Configuration Protocol) server function. The IP address will automatically be determined.
- 6 When you are finished, press **EXIT**.



CAUTION

- Do not connect a modular phone cable to the LAN port.
- Since there are various connection methods, please follow the specifications of your telecommunication carrier or internet service provider.

Connecting to a wireless network

- 1 Press **SETTINGS** to access the main menus.
- 2 Press the navigation buttons to scroll to **NETWORK** and press **OK**.
- 3 Press the navigation buttons to select **Network Setting** and press **OK**.
- 4 **Select Setting from the AP list or Simple setting (WPS-button mode).**
-Setting from the AP list
 Select an AP to connect to a wireless network.
-Simple setting (WPS-button mode)
 Press the button on the wireless router that supports PBC to easily connect to the router.
- 5 When you are finished, press **EXIT**.



CAUTION

- Network setting menu will not be available until the display connected to physical network.
- Since there are various connection methods, please follow the specifications of your telecommunication carrier or internet service provider.



NOTE

- If you want to access the Internet directly on your display, the Internet connection should always be on.
- If you cannot access the Internet, check the network conditions from a PC on your network.
- When you use Network Setting, check the LAN cable or check if DHCP in the router is turned on.
- If you do not complete the network settings, the network may not work properly.

Tips for Network setting

- Use a standard LAN cable with this display. Cat5 or better with a RJ45 connector.
- Many network connection problems during set up can often be fixed by re-setting the router or modem. After connecting the display to the home network, quickly power off and/or disconnect the power cable of the home network router or cable modem. Then power on and/or connect the power cable again.
- Depending on the internet service provider (ISP), the number of devices that can receive internet service may be limited by the applicable terms of service. For details, contact your ISP.
- LG is not responsible for any malfunction of the display and/or the internet connection feature due to communication errors/malfunctions associated with your internet connection, or other connected equipment.
- LG is not responsible for problems within your internet connection.
- You may experience undesired results if the network connection speed does not meet the requirements of the content being accessed.
- Some internet connection operations may not be possible due to certain restrictions set by the Internet service provider (ISP) supplying your Internet connection.
- Any fees charged by an ISP including, without limitation, connection charges are your responsibility.
- A 10 Base-T or 100 Base-TX LAN port is required when using a wired connection to this display. If your internet service does not allow for such a connection, you will not be able to connect the display.
- A DSL modem is required to use DSL service and a cable modem is required to use cable modem service. Depending on the access method of and subscriber agreement with your ISP, you may not be able to use the Internet connection feature contained in this display or you may be limited to the number of devices you can connect at the same time. (If your ISP limits subscription to one device, this display may not be allowed to connect when a PC is already connected.)
- The use of a router may not be allowed or its usage may be limited depending on the policies and restrictions of your ISP. For details, contact your ISP directly.

Tips for Wireless Network Setting

- Wireless networks can be subject to interference from other devices operating at a frequency of 2.4 GHz (wireless phones, Bluetooth devices, or microwave ovens). There may also be interference from devices with a frequency of 5 GHz, same as other Wi-Fi devices.
- The surrounding wireless environment can cause the wireless network service to run slowly.
- For an AP connection, an access point device that supports wireless connection is required and the wireless connection feature must be enabled on the device. Contact your service provider regarding availability of wireless connection on your access point.
- Check the SSID and security settings of the AP for AP connection. Refer to the appropriate documentation for SSID and security settings of the AP.
- Invalid settings on network devices (wired/wireless line sharer, hub) can cause the monitor to run slowly or not operate properly. Install the devices correctly according to the appropriate manual and set the network.
- Connection method may differ according to the AP manufacturer.

Network Status

- 1 Press **SETTINGS** to access the main menus.
- 2 Press the navigation buttons to scroll to **NETWORK** and press **OK**.
- 3 Press the navigation buttons to select **Network Status**.
- 4 Press **OK** to check the network status.
- 5 When you are finished, press **EXIT**.

Option	Description
Setting	Return to the network setting menu.
Test	Test the current network status after setting the network.
Close	Return to the previous menu.

Using the My Media

Connecting USB storage devices

Connect USB storage devices such as a USB flash memory, external hard drive to the display and use multimedia features.

Connect a USB flash memory or USB memory card reader to the Display as shown on the following illustration. The **My Media** screen appears.

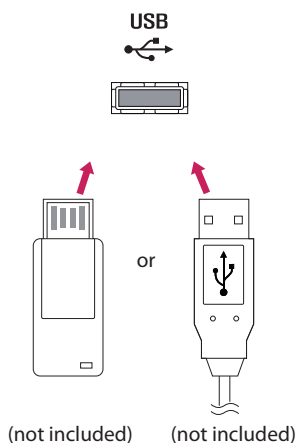

CAUTION

- Do not turn the display off or remove a USB storage device while **MY MEDIA** menu is activated, as this could result in loss of files or damage to the USB storage device.
- Back up your files saved on a USB storage device frequently, as you may lose or damage the files and this may be not covered by the warranty.

Tips for using USB storage devices

- Only a USB storage device is recognizable.
- If the USB storage device is connected through a USB hub, the device is not recognizable.
- A USB storage device using an automatic recognition program may not be recognized.
- A USB storage device which uses its own driver will not be recognized.
- The recognition speed of a USB storage device may depend on each device.
- Please do not turn off the display or unplug the USB device when the connected USB storage device is working. When such a device is suddenly separated or unplugged, the stored files or the USB storage device may be damaged.
- Please do not connect the USB storage device which was artificially maneuvered on the PC. The device may cause the product to malfunction. Only use a USB storage device which has normal music files, image files or movie files.
- Please only use USB storage devices formatted using the FAT32 file system. Storage devices formatted with utility programs that are not supported by Windows may not be recognized.
- Please connect power to a USB storage device (over 0.5 A) which requires an external power supply. If not, the device may not be recognized.
- Please connect a USB storage device with the cable included by the device maker.
- Some USB storage devices may not be supported or operate smoothly.
- File alignment method of USB storage devices is similar to Window XP and the monitor can recognize up to 100 English characters.
- Be sure to back up important files since data stored on a USB memory device may be damaged. We will not be responsible for any data loss.
- If the USB HDD does not have an external power source, the USB device may not be detected. So be sure to connect the external power source.
 - Please use a power adaptor for an external power source. USB cable does not provide to connect an external power source.
- If your USB memory device has multiple partitions, or if you use a USB multi-card reader, you can use up to 4 partitions or USB memory devices.
- If a USB memory device is connected to a USB multi-card reader, its volume data may not be detected.
- If the USB memory device does not work properly, disconnect and reconnect it.
- How fast a USB memory device is detected differs from device to device.
- If the USB is connected in Standby Mode, that drive will automatically be loaded when the display is turned on.
- The recommended capacity is 1 TB or less for a USB external hard disk and 32 GB or less for USB memory.
- Any device with more than the recommended capacity may not work properly.
- If a USB external hard disk with a Energy Saving function does not work, turn the hard disk off and on again to make it work properly.
- USB storage devices below USB 2.0 are supported as well. But they may not work properly with videos.
- A maximum of 999 folders or files can be recognized under one folder.
- It is recommended you use a certified USB storage device and cable. Otherwise, a USB storage device may not be detected or a playback error may occur.
- Only a USB memory device can be used to play back the files distributed and stored by SuperSign Manager. A USB hard disk or multi-card reader will not work.
- Only an FAT 32 file formatted storage device can play back the files distributed and stored by SuperSign manager.
- A USB 3.0 storage device may not work.
- Data on some USB storage devices may be damaged in a high temperature environment.
- It is recommended that you avoid playing contents using more than two USB ports simultaneously.

Browsing Files

Browse files saved in a USB storage device.

- 1 Press **SETTINGS** to access the main menu.
- 2 Press the search button to scroll to **MY MEDIA** and press **OK**.
- 3 Press the Search button to go to the **Movie List, Photo List, Music List**, or **Content List** that you want, and press **OK**.

Supported file format









Type	Supported file format			
Movie	Video	Codec	Media Container	Profile
		MPEG1 / MPEG2	DAT, MPG, MPEG, TS, TP	1080P @ 30 fps
		MPEG4 (DivX 3.11, DivX 4, DivX 5, DivX 6, Xvid 1.01, Xvid 1.02, Xvid 1.03, Xvid 1.10-beta1/2)	AVI, DIVX, MP4, MKV, TS, TRP	1080P @ 30 fps
	H.264	AVI, MP4, MKV, TS, TRP, TP	1080P @ 60 fps	
	Audio	MP3	MP3	8 kbps to 320 kbps (Bit rate) 16 kHz to 48 kHz (Sample rate)
		AC3	AC3	32 kbps to 640 kbps (Bit rate) 32 kHz, 44.1 kHz, 48 kHz (Sample rate)
		MPEG	MP3	32 kbps to 448 kbps (Bit rate) 16 kHz to 48 kHz (Sample rate)
		AAC, HEAAC	MP4	8 kHz to 48 kHz (Sample rate)
		LPCM	AVI, WAV	64 kbps to 1.5 Mbps (Bit rate) 8 kHz to 48 kHz (Sample rate)
	Bit rate : within 8 kbps to 320 kbps(MP3) External Subtitle format : *.smi/*srt/*sub(MicroDVD, Subviewer1.0/2.0)/*.ass/*ssa/*txt(TMPlayer)/*.psb(PowerDivX) Internal Subtitle format : only, XSUB (It is the subtitle format used in DivX6 files)			

Type	Supported file format
Photo	JPEG Baseline : 64 x 64 to 15360 x 8640 Progressive : 1920 x 1440 PNG Interlace : 1200 x 800 BMP 9600 x 6400 <ul style="list-style-type: none"> • Non-supported files are displayed in the form of predefined icon.
Music	MP3 Bit rate : 8 kbps to 320 kbps <ul style="list-style-type: none"> • Sampling rate MPEG1/2 Layer3 : 16 kHz to 48 kHz
Content (when using SuperSign Manager)	File Extensions : *.cts/*cse Movie File Extensions: *.mpg/*mpeg/*dat/*ts/*trp/*tp/*mp4/*mkv/*avi/*avi(motion JPEG)/*mp4(motion JPEG)/*mkv(motion JPEG) Video format: MPEG1, MPEG2, MPEG4,H.264, DivX 3.11, DivX 4, DivX 5, DivX 6, Xvid 1.00,Xvid 1.01, Xvid 1.02, Xvid 1.03,Xvid 1.10-beta1/2, JPEG Audio format: MP3, Dolby Digital, LPCM, AAC, HE-AAC

Viewing Movies

Plays movie files saved in the USB storage device.

- 1 Press **SETTINGS** to access the main menu.
- 2 Press the navigation button to scroll to **MY MEDIA** and press **OK**.
- 3 Press the navigation button to scroll to **Movie List** and press **OK**.
- 4 Press the navigation buttons to scroll to a folder you want and press **OK**.
- 5 Press the navigation buttons to scroll to a file you want and press **OK**.
 - **Change Device** : Selects the USB storage device.
 - **Go to root folder** : Returns to the home screen of My Media.
 - **Go to upper folder** : Returns to the previous screen.
 - **Exit** : Exits My Media.
- 6 During movie playback, press **OK** to access the following settings.

Remote button	Description
	Stops the playback.
	Plays a video.
	Pauses or resumes the playback.
	Scans backward in a file.
	Scans forward in a file.
	Adjusts the screen brightness to save energy.
SETTINGS	Show the Option menu.
 BACK	Hide the menu on the full-sized screen.
EXIT	Returns to Movie List .
	Skips to specific points in a file during playback. The time of a specific point will appear on the status bar. In some files, this function may not work properly.

Tips for using playing video files

- Some user-created subtitles may not work properly.
- Some special characters are not supported in subtitles.
- HTML tags are not supported in subtitles.
- Subtitles in languages other than the supported languages are not available.
- The screen may suffer temporary interruptions (image stoppage, faster playback, etc.) when the audio language is changed.
- A damaged movie file may not be played correctly, or some player functions may not be usable.
- Movie files produced with some encoders may not be played correctly.
- If the video and audio structure of recorded file is not interleaved, either video or audio is outputted.
- HD videos with a maximum of 1920 X 1080 @ 25/30P or 1280 X 720 @ 50/60P are supported, depending on the frame.
- Videos with resolutions higher than 1920 X 1080 @ 25/30P or 1280 X 720 @ 50/60P may not work properly depending on the frame.
- Movie files other than the specified types and formats may not work properly.
- Max bitrate of playable movie file is 20 Mbps. (only, Motion JPEG : 10 Mbps)
- We do not guarantee smooth playback of profiles encoded level 4.1 or higher in H.264/AVC.
- DTS Audio codec is not supported.
- A movie file more than 30 GB in file size is not supported for playback.
- A DivX movie file and its subtitle file must be located in the same folder.
- A video file name and its subtitle file name must be identical for it to be displayed.
- Playing a video via a USB connection that doesn't support high speed may not work properly.
- Files encoded with GMC(Global Motion Compensation) may not be played.

Video options

- 1 Press **SETTINGS** to access the Pop-Up menus.
- 2 Press the navigation buttons to scroll to **Set Video Play**, **Set Video**, or **Set Audio**, and press **OK**.

NOTE

- The option values changed in **Movie List** do not affect **Photo List** or **Music List**. Therefore, they are not affected by option values changed in **Photo List** or **Music List**.
- The option values changed in **Photo List** and **Music List** do affect each other.
- When replaying the video file after stopping, you can play from where it stopped previously.

Select **Set Video Play** to access the following menus:

Menu	Description
Picture Size	Selects your desired picture format during movie play.
Audio Language	Changes the Language Group of the audio during movie play. Files with a single audio track cannot be selected.
Subtitle Language	Turn on/off the subtitle.
Language	Activated for SMI subtitle and can select the language within the subtitle.
Code Page	Can select the font for subtitle. When set to default, same font as general menu will be used.
Sync	Adjusts the time synchronisation of the subtitle from -10 secs to +10 secs by steps of 0.5 secs during movie play.
Position	Changes the position of the subtitle either up or down during movie play.
Size	Selects your desired Subtitle size during movie play.
Repeat	Turn on/off repeat function of movie playback. When turned on, the file within the folder will be played back repeatedly. Even when the repeated playback is turned off, it can run the playback if the file name is similar to the previous file.

NOTE

- Only 10,000 of sync blocks can be supported within the subtitle file.
- When playing a video, you can adjust the picture size by pressing the **ARC** button.
- Subtitles in your language are only supported when the OSD menu is also in this language.
- The code page options may be disabled depending on the language of the subtitle files.
- Select the appropriate code page for the subtitle files.

Viewing Photos

View image files saved in the USB storage device.

- 1 Press **SETTINGS** to access the main menu.
- 2 Press the navigation button to scroll to **MY MEDIA** and press **OK**.
- 3 Press the navigation button to scroll to **Photo List** and press **OK**.
- 4 Press the navigation buttons to scroll to a folder you want and press **OK**.
- 5 Press the navigation buttons to scroll to a file you want and press **OK**.

- **Change Device** : Selects the USB storage device.
- **Go to root folder** : Returns to the home screen of My Media.
- **Go to upper folder** : Returns to the previous screen.
- **Exit** : Exits My Media.

- 6 While viewing photos, you can access the following settings.



Menu	Description
Slideshow	Starts or stops a slideshow with selected photos. If there are no selected photos, all photos saved in the current folder display during a slideshow. To set a slideshow speed, select Option .
BGM	Turns the background music on or off. To set the background music folder, select Option . You can adjust option by SETTINGS button on the remote control.
	Rotates photos clockwise (90 °, 180 °, 270 °, 360 °). NOTE <ul style="list-style-type: none"> • The supported photo size is limited. You cannot rotate a photo if the resolution of the rotated width is larger than the supported resolution size.
	Enlarges the photo by 100 %, 200 % or 400 %. NOTE <ul style="list-style-type: none"> • Photos with a resolution of 100 x 100 or less cannot be enlarged.
	Reduces power consumption by adjusting peak screen brightness.
Option	To display the OPTIONS .
Hide	Hides the option window. To display the options, press OK .
Exit	Return to Photo List .

Photo options

- 1 Press **SETTINGS** to show the **Option** menus.
- 2 Press the navigation buttons to scroll to **Set Photo View**, **Set Video**, or **Set Audio**, and press **OK**.

NOTE

- The option values changed in **Movie List** do not affect **Photo List** or **Music List**. Therefore, they are not affected by option values changed in **Photo List** or **Music List**.
- The option values changed in **Photo List** and **Music List** do affect each other.









Select **Setting Photo View** to access the following menus:

Menu	Description
Slide Speed	Select a slideshow speed. (Options: Fast, Medium, or Slow.)
BGM	Selects a music folder for the background music.
Repeat	Plays background music on repeat.
Random	Plays background music in random order.

Listening to Music

Plays music files saved in the USB storage device.









- 1 Press **SETTINGS** to access the main menu.
- 2 Press the navigation button to scroll to **MY MEDIA** and press **OK**.
- 3 Press the navigation button to scroll to **Music List** and press **OK**.
- 4 Press the navigation buttons to scroll to a folder you want and press **OK**.
- 5 Press the navigation buttons to scroll to a file you want and press **OK**.
 - **Change Device** : Selects the USB storage device.
 - **Go to root folder** : Returns to the home screen of My Media.
 - **Open Music Player** : Opens the settings window for music. This feature is activated only during playback.
 - **Go to upper folder** : Returns to the previous screen.
 - **Exit** : Exits My Media.
- 6 During music playback, press **OK** or the blue button () to access the following settings.

Remote button	Description
	Stops playing back the file and moves back to the Music List .
	Plays a music file.
	Pauses or resumes playback.
	Skips to the previous file.
	Skips to the next file.
	Reduces power consumption by adjusting peak screen brightness. (Off and Screen Off work only.)
SETTINGS	Show the Option menu.
 BACK	Hides the option window. To display the options, press OK .
EXIT	Return to Music List .
	Skips to specific points in a file during playback. The time of a specific point will appear on the status bar. In some files, this function may not work properly.

Tips for playing music files

- This unit cannot support the ID3 Tag embedded MP3 files.

NOTE

- A damaged or corrupted music file does not play but displays 00:00 in playtime.
- A music downloaded from a paid service with copyright protection does not start but displays inappropriate information in playtime.
- If you press **OK**,  buttons, screen saver is stopped.
- The , , , ,  buttons on the remote control are also available in this mode.
- You can use the  button to select the next music and the  button to select the previous music.

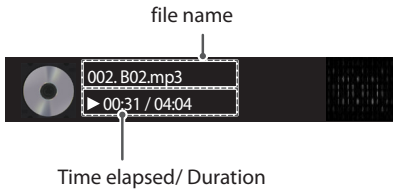
**Music options**

- 1 Press **SETTINGS** to access the pop-up menus.
- 2 Press the navigation buttons to scroll to **Set Audio Play** or **Set Audio** and press **OK**.

NOTE

- The option values changed in **Movie List** do not affect **Photo List** or **Music List**. Therefore, they are not affected by option values changed in **Photo List** or **Music List**.
- The option values changed in **Photo List** and **Music List** do affect each other.

When you select the **Set Audio Play**,

Menu	Description
Repeat	Repeats the music playback.
Random	Plays random music tracks.

Viewing the Contents List

Plays back the stored files using the **Export** option in **SuperSign Manager**.

- 1 Press **SETTINGS** to access the main menu.
- 2 Press the navigation button to scroll to **MY MEDIA** and press **OK**.
- 3 Press the navigation button to scroll to **Contents List** and press **OK**.
- 4 Press the navigation buttons to scroll to a folder you want and press **OK**.
- 5 Press the navigation buttons to scroll to a file you want and press **OK**.

- **Change Device** : Selects the USB storage device.
- **Go to root folder** : Returns to the home screen of My Media.
- **Go to upper folder** : Returns to the previous screen.
- **Exit** : Exits My Media.



NOTE

- While playing media files from **Contents List**, only the **BACK**, **EXIT**, or volume button are available. Selecting the **BACK** or **EXIT** button stops playing media files and returns to the **Contents List**.
- When you use the distribution feature which utilizes SuperSign Software, the storage device used to store contents is determined based on the size of the remaining memory space. (Note: If USB ports 1 and 2 have the same memory space, contents will be saved on the storage device connected to USB port 1.)
- If there is the AutoPlay folder in the USB device and its files are in supported formats, they can be played back automatically when the USB device is connected to the monitor.
- It is recommended that you avoid playing contents using more than two USB ports simultaneously.
- With respect to the playback of distribution or contents schedules through SuperSign Software, the schedule executed last time is played.

CUSTOMIZING SETTINGS

Accessing Main Menus

- 1 Press **SETTINGS** to access the main menus.
 - 2 Press the navigation buttons to scroll to one of the following menus and press **OK**.
 - 3 Press the navigation buttons to scroll to the setting or option you want and press **OK**.
 - 4 When you are finished, press **EXIT**. When you return to the previous menu, press **BACK**.
- **PICTURE** : Adjusts the image size, quality, or effect.
 - **AUDIO** : Adjusts the sound quality, effect, or volume level.
 - **TIME** : Sets the time, date, or timer feature.
 - **OPTION** : Customizes the general settings.
 - **NETWORK** : Sets up the network setting.
 - **MY MEDIA** : Display and play movie, photo and music contents stored on your USB or signage device (Internal storage device).

PICTURE Settings

- 1 Press **SETTINGS** to access the main menus.
- 2 Press the navigation buttons to scroll to **PICTURE** and press **OK**.
- 3 Press the navigation buttons to scroll to the setting or option you want and press **OK**.
- To return to the previous level, press **BACK**.
- 4 When you are finished, press **EXIT**.
When you return to the previous menu, press **BACK**.

The available picture settings are described in the following:

Setting	Description	
Energy Saving	Reduces power consumption by adjusting peak screen brightness.	
	Level	
	Off	Disables Energy Saving function.
	Minimum/ Medium/ Maximum	Selects the brightness level of the backlight.
	Screen Off	The screen turns off in 3 seconds.
Smart Energy Saving	Adjusts the backlight and contrast depending on the screen brightness.	
	Level	
	Off	Disables the Smart Energy Saving function.
	On	Enables the Smart Energy Saving function to save power consumption as much as the value set in the smart energy saving rate.
Picture Mode	Selects the picture mode optimized for the viewing environment or the programme.	
	Mode	
	Vivid	Heightens contrast, brightness, and sharpness to display vivid images.
	Standard	Displays images in standard levels of contrast, brightness, and sharpness.
	APS	APS (Auto power saving) mode reduces power consumption by dimming control.
	Cinema	Optimizes the video image for a cinematic look to enjoy movies as if you are in a movie theater.
	Sport	Optimizes the video image for high and dynamic actions by emphasizing primary Colors such as white, grass, or sky blue.
	Game	Optimizes the video image for a fast gaming screen such as PCs or games.
	Calibration	Applies user-customized white balance based on Standard.
	Expert1-2	Menu for adjusting picture quality that allows experts and amateurs to enjoy the best Monitor viewing.
Aspect Ratio	Changes the image size to view images at its optimal size.	

Setting	Description
Screen (In RGB Mode Only)	Customizes the PC display options in RGB mode.
	Option
	Resolution Selects a proper resolution.
	Auto Configure Sets to adjust the screen position, clock, and phase automatically. The displayed image may be unstable for a few seconds while the configuration is in progress.
	Position/Size/Phase Adjusts the options when the picture is not clear, especially when characters are shaky, after the auto configuration.
Reset Restores the options to the default setting.	

Basic image options

Setting	Description
Backlight	Adjusts the brightness of the screen by controlling the LCD backlight. If you decrease the brightness level, the screen becomes darker and the power consumption will be reduced without any video signal loss.
Contrast	Increases or decreases the gradient of the video signal. You may use Contrast when the bright part of the picture is saturated.
Brightness	Adjusts the base level of the signal in the picture. You may use Brightness when the dark part of the picture is saturated.
Sharpness	Adjusts the level of crispness in the edges between the light and dark areas of the picture. The lower the level, the softer the image.
Color	Adjusts intensity of all colors.
Tint	Adjusts the balance between red and green levels.
Color Temp.	Set to warm to enhance hotter Colors such as red, or set to cool to make picture bluish.
Advanced Control/Expert Control	You can adjust the picture for each Picture Mode , or adjust the picture settings according to a specific picture image. First, select a desired Picture Mode . * This option is unavailable if Picture Mode is set to Vivid .
Picture Option	Sets additional picture option.
Picture Reset	Restores the options to the default setting.

! NOTE

- When you select a picture mode, related menus are set automatically.
- When using the Smart Energy Saving function, the screen may look saturated in the white area of a still image.
- If Energy Saving is set to Minimum, Medium, or Maximum, the Smart Energy Saving function is disabled.

Advanced Control - Picture Mode (Standard/ APS/ Sport/ Game/ Calibration)

Setting	Description
Dynamic Contrast	Adjusts the contrast to the optimal level according to the brightness of the image.
Dynamic Color	Adjusts color for more natural-looking colors.
Color Gamut	Selects the range of colours that can be expressed.
Skin Color	Skin color spectrum can be separately set to implement the skin color as defined by the user.
Sky Color	Sky color is set separately.
Grass Color	Natural color spectrum (meadows, hills, etc.) can be separately set.
Gamma	Sets the gradation curve according to the output of the picture signal in relation to the input signal.

Expert Control - Picture Mode (Cinema/ Expert1/ Expert2)

Setting	Description
Dynamic Contrast	Adjusts the contrast to the optimal level according to the brightness of the image. (Function works in the following mode - HDMI-DTV)
Color Gamut	Selects the range of colours that can be expressed.
Edge Enhancer	Shows clearer and distinctive yet natural edges of the video.
Color Filter	Filters a specific colour spectrum in RGB colours to fine-tune colour saturation and hue accurately.
Color Temperature	Adjusts the overall tone of the screen as desired. In Expert mode, detailed fine-tuning can be set via Gamma method, etc.
Color Management System	This is a system that experts use when they adjust colour with a test pattern. They can select from six colour areas (Red / Green / Blue / Cyan / Magenta / Yellow) without affecting other colours. For normal images, adjustments may not result in noticeable colour changes.

Picture Option - HDMI(DTV) Mode

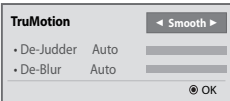
Setting	Description
Noise Reduction	Reduces screen noise in the video.
MPEG Noise Reduction	Reduces noise caused by compressing digital video.
Black Level	Adjusts the brightness or darkness of the screen to suit the black level of the picture input using the degree of darkness (black level) of the screen.
Real Cinema	Optimizes the screen for movie viewing.
TruMotion (This feature is supported by 65SE3B and 65SE3KB only.)	<p>Corrects images to display smoother motion sequences.</p> <ul style="list-style-type: none"> • Off : Turn off the TruMotion. • Smooth/ Clear : De-Judder / De-Blur can be set Auto. • User : De-Judder / De-Blur can be set manually. <ul style="list-style-type: none"> - De-Judder : This function adjusts juddering of the screen. - De-Blur : This function adjusts and eliminates blurring of the screen. 

AUDIO Settings

- 1 Press **SETTINGS** to access the main menus.
- 2 Press the navigation buttons to scroll to **AUDIO** and press **OK**.
- 3 Press the navigation buttons to scroll to the setting or option you want and press **OK**.
- To return to the previous level, press **BACK**.
- 4 When you are finished, press **EXIT**.
When you return to the previous menu, press **BACK**.

The available audio options are described in the following:

Setting	Description	
Sound Mode	Allows optimized sound for custom Monitor installation.	
	Level	
	Standard	Suitable for all types of video.
	News/ Music/ Cinema/ Sport/ Game	Sets audio optimized for a specific genre.
Sound Effect	the user can select various sound effects. - Sound Effect function is available only for Standard mode in Sound Mode menu.	
	Level	
	Clear Voice II	Boosts voice clarity.
	Virtual Surround	LG's proprietary audio processing technology allows 5.1ch-like surround sound from two speakers. - If Clear Voice II is set to On , Virtual Surround will not be chosen.
	Equalizer	Adjusts the volume to a level of your choice using the Equalizer.
	Balance	Adjusts left/right audio balance.
	Reset	You can reset the settings under the Sound Effects menu.
AV Sync. Adjust	Synchronizes video and audio directly when they do not match. If you set AV Sync. to ON , you can adjust the sound output to the screen image. <ul style="list-style-type: none"> • Speaker: Adjusts the synchronization of the sound from the speakers. The "-" button makes the sound output faster and the "+" button slower than the default value. • Bypass: The audio of an external device without audio delay. Audio may be output before video as it takes time to process video input into the Monitor. 	

! NOTE

- Some models may not have built-in speakers. In that case, you need to connect external speakers to listen to sound.

TIME Settings

- 1 Press **SETTINGS** to access the main menus.
- 2 Press the navigation buttons to scroll to **TIME** and press **OK**.
- 3 Press the navigation buttons to scroll to the setting or option you want and press **OK**.
- To return to the previous level, press **BACK**.
- 4 When you are finished, press **EXIT**.
When you return to the previous menu, press **BACK**.

The available time settings are described in the following:

Setting	Description	
Clock	Sets the time feature.	
	Level	
	Auto	The current time is entered according to the selected country when connected to a network.
	Manual	The current time needs to be entered manually.
On/Off Time	Sets the time to turn on or off the monitor set.	
Auto Off (15Min.)	If Auto-off is active and there is no input signal, the set switches to off mode automatically after 15 minutes.	
Automatic Standby	If the monitor is left unattended for a set period of time, it automatically goes into standby mode.	

NOTE

- Off Time/ On Time can be saved for up to seven schedules; the monitor is turned on or off at the preset time in the schedule list. If multiple preset times are stored in the schedule list, this function works at the nearest time from the current time.
- Once the on or off time is set, these functions operate daily at the preset time.
- When the scheduled power-on and power-off times are the same, the power-off time has priority over the power-on time if the set is turned on, and vice versa if the set is turned off.
- If port 123 is blocked by a firewall, your monitor cannot receive the current time from the network.

OPTION Settings

- 1 Press **SETTINGS** to access the main menus.
- 2 Press the navigation buttons to scroll to **OPTION** and press **OK**.
- 3 Press the navigation buttons to scroll to the setting or option you want and press **OK**.
- To return to the previous level, press **BACK**.
- 4 When you are finished, press **EXIT**.
When you return to the previous menu, press **BACK**.

The available option settings are described in the following:

Setting	Description
Language	Selects a language for the display text.
Country	Select your country.
DivX(R) VOD	Registers or releases DivX. Checks DivX Registration Code for playing DivX-protected videos. Register at http://vod.divx.com . Uses Registration Code to rent or purchase movies at www.divx.com/vod . * Rented/purchased DivX files cannot be played if the DivX Registration Code of a different device is used. Use only the DivX Registration Code granted to this device. * Converted files not conforming to the DivX Codec Standard may not play or may produce abnormal images.
Initial Setting	Deletes all optional settings and returns to initial default mode.
Set ID	You can assign a unique Set ID NO (name assignment) to each product when several products are connected for display. Specify the number (1 to 255 or 1 to 1,000) using the button and exit. Use the assigned Set ID to individually control each product using the Product Control Program.
Tile Mode	Tile Mode To use this function - Must be displayed with various other products. - Select Tile Mode, set rows and columns, and then enter the tile ID to set the location. - Tile Mode: row x column (row = 1-15, column = 1-15). - 15 x 15 available.
	Auto Config. Sets to adjust the screen position, clock, and phase automatically. The displayed image may be unstable for a few seconds while the configuration is in progress.
	Position Moving the screen position horizontally and vertically.
	Size Adjust the horizontal and vertical size of the screen taking into account the size of the bezel.
	Natural The image is omitted by the distance between the screens to be naturally shown.
	Reset Function to initialize and release Tile. All Tile setting are released when selecting Tile recall and the screen returns to Full screen.

SETTINGS	Description
Contents Schedule	Creates simple schedules and sets playback using files in My Media.
	Level
	Add Schedule Creates a contents schedule. - Media: Select the file to which you want to apply the contents schedule. - Select [Create] to register the contents schedule.
	Play Plays a contents schedule.
	Delete All Deletes all registered schedules.
	<div data-bbox="281 448 404 491">  NOTE </div> <ul data-bbox="303 504 1011 874" style="list-style-type: none"> • Information about registered schedules is stored on your USB storage device. This feature does not work when your USB storage device has been removed. • The picture size is 1920 x 1080. • You can use photo and video files only. • You can add up to 50 files (photo files + video files = 50). • Only photos whose resolution is 1920 x 1080 or below are supported. • The default display time for photos is 1 minute. Playback time for movies differs depending on the running time. • You can create up to 7 schedules. • You cannot register a schedule when no file has been selected. • Contents schedules that have had information forcibly modified using a PC, etc. may not function properly. • With respect to the playback of distribution or contents schedules through SuperSign Software, the schedule executed last time is played.

Tile Mode

This monitor can be tiled with additional monitors to create a large tiled display.

Off

When the Tile Mode option is disabled

1X2

When using 2 monitors



2X2

When using 4 monitors



3X3

When using 9 monitors



4X4

When using 16 monitors



5X5

When using 25 monitors



Tile Mode - Natural mode

When active, the part of the image that would normally be displayed in the gap between the monitors is omitted.

Before



After



NETWORK Settings

- 1 Press **SETTINGS** to access the main menus.
- 2 Press the navigation buttons to scroll to **NETWORK** and press **OK**.
- 3 Press the navigation buttons to scroll to the setting or option you want and press **OK**.
- To return to the previous level, press **BACK**.
- 4 When you are finished, press **EXIT**.
When you return to the previous menu, press **BACK**.

The available option settings are described in the following:

Setting	Description
Network Setting	Configure the network settings.
	Network setting When the Wi-Fi dongle is connected, you can view and connect to any available wireless network.
Network Status	Display the network status.

Network Connection Options

Setting	Description
Setting from the AP list	Select an AP to connect to a wireless network.
Simple setting (WPS-button mode)	Press the button on the wireless router that supports PBC to easily connect to the router.

TROUBLESHOOTING

No image is displayed

Problem	Action
Is the product power cord connected?	<ul style="list-style-type: none"> Check if the power cord is correctly plugged into the power outlet.
Does the Out of range message appear?	<ul style="list-style-type: none"> The signal from the PC (video card) is out of the vertical or horizontal frequency range of the product. Adjust the frequency range by referring to the Specifications in this manual.
Does the Check signal cable message appear?	<ul style="list-style-type: none"> The signal cable between PC and product is not connected. Check the signal cable. Press the INPUT menu in the remote Control to check the input signal.

The Unknown Product message appears when the product is connected.

Problem	Action
Did you install the driver?	<ul style="list-style-type: none"> Check if the Plug & Play function is supported by referring to the video card user manual.

The screen image looks abnormal.

Problem	Resolution
Is the screen position wrong?	<ul style="list-style-type: none"> D-Sub analog signal - Press the "AUTO" button in the remote control to automatically select the optimal screen status that fits into the current mode. If adjustment is not satisfactory, select [PICTURE] - [Screen] - [Position] in OSD menu. See if the video card resolution and frequency are supported by the product. If the frequency is out of range, set to the recommended resolution in the Control Panel "Display" Setting menu.
Do thin lines appear on the background screen?	<ul style="list-style-type: none"> D-Sub analog signal - Press the "AUTO" button in the remote control to automatically select an optimal screen status that fits into the current mode. If adjustment is not satisfactory, select [PICTURE] - [Screen] - [Size] in OSD menu.
Horizontal noise appears or the characters look blurred.	<ul style="list-style-type: none"> D-Sub analog signal - Press the "AUTO" button in the remote control to automatically select an optimal screen status that fits into the current mode. If adjustment is not satisfactory, select [PICTURE] - [Screen] - [Phase] in OSD menu.
The screen is displayed abnormally.	<ul style="list-style-type: none"> The proper input signal is not connected to the signal port. Connect the signal cable that matches with the source input signal.

After-image appears on the product.

Problem	Action
After-image appears when the product is turned off.	<ul style="list-style-type: none"> • If you use a fixed image for a long time, the pixels may be damaged. Use the screen-saver function. • When a dark image is displayed on the screen after an image with high contrast (black and white or gray), this may cause image sticking. This is normal for LCD screen products.

The audio function does not work.

Problem	Action
No sound?	<ul style="list-style-type: none"> • See if the audio cable is connected properly. • Adjust the volume. • See if the sound is set properly.
Sound is too dull.	<ul style="list-style-type: none"> • Select the appropriate equalizer sound.
Sound is too low.	<ul style="list-style-type: none"> • Adjust the volume.

Screen color is abnormal.

Problem	Action
Screen has poor color resolution (16 colors).	<ul style="list-style-type: none"> • Set the number of colors to more than 24 bits (true color). Select Control Panel - Display - Settings - Color Table menu in Windows.
Screen color is unstable or mono-colored.	<ul style="list-style-type: none"> • Check the connection status of the signal cable. Or, re-insert the PC video card.
Do black spots appear on the screen?	<ul style="list-style-type: none"> • Several pixels (red, green, white, or black color) may appear on the screen, which can be attributable to the unique characteristics of the LCD panel. This is not a malfunction of the LCD.

The operation does not work normally.

Problem	Action
The power suddenly turned off.	<ul style="list-style-type: none"> • Is Off Timer set? • Check the power control settings. Power interrupted.

PRODUCT SPECIFICATIONS

The product specifications below may be changed without prior notice due to upgrade of product functions.
 “~” refers to alternating current (AC), and “= ” refers to direct current (DC).

LCD Panel	Screen Type	LCD (Liquid Crystal Display) Panel.
Video Signal	Max. Resolution	1920 x 1080 @ 60 Hz - It may not be supported depending on the OS or video card type.
	Recommended Resolution	1920 x 1080 @ 60 Hz - It may not be supported depending on the OS or video card type.
	Horizontal Frequency	RGB : 30 kHz to 83 kHz HDMI : 30 kHz to 83 kHz
	Vertical Frequency	RGB : 50 Hz to 75 Hz HDMI : 56 Hz to 60 Hz
	Synchronization Type	Separate Sync, Digital
Input Connector	**SE3B	HDMI, DVI-D, RGB, Audio IN/OUT, Speaker OUT, EXT IR IN, USB, RS-232C IN/OUT, LAN
	**SE3KB	HDMI, DVI-D, RGB, Audio IN/OUT, EXT IR IN, USB, RS-232C IN/OUT, LAN
Embedded battery		Applied
Environmental conditions	Operating Temperature Operating Humidity	0 °C to 40 °C 10 % to 80 %
	Storage Temperature Storage Humidity	-20 °C to 60 °C 5 % to 95 %

* **Applicable only for models that support the speakers**

Audio/AUDIO	RMS Audio Output	10 W + 10 W (R + L)
	Input Sensitivity	0.7 Vrms
	Speaker Impedance	6 Ω

32SE3B

LCD Panel	Pixel Pitch	0.36375 mm (H) x 0.36375 mm (V)
Power	Rated Voltage	AC 100-240 V~ 50/60 Hz 1.4 A
	Power Consumption	On Mode : 50 W Typ. Sleep Mode (RGB) : ≤ 0.7 W Sleep Mode (HDMI) : ≤ 0.7 W Off Mode : ≤ 0.5 W
Dimensions (Width x Height x Depth) / Weight	Head	729.4 mm x 428.9 mm x 55.5 mm / 5.2 kg
	Head + Stand	729.4 mm x 481 mm x 154.2 mm / 6 kg
	Head + Speaker	729.4 mm x 428.9 mm x 95.7 mm / 5.7 kg
	Head + Speaker + Stand	729.4 mm x 481 mm x 154.2 mm / 6.5 kg

32SE3KB

LCD Panel	Pixel Pitch	0.36375 mm (H) x 0.36375 mm (V)
Power	Rated Voltage	AC 100-240 V~ 50/60 Hz 1.4 A
	Power Consumption	On Mode : 50 W Typ. Sleep Mode (RGB) : ≤ 0.7 W Sleep Mode (HDMI) : ≤ 0.7 W Off Mode : ≤ 0.5 W
Dimensions (Width x Height x Depth) / Weight	Head	729.4 mm x 428.9 mm x 55.5 mm / 5.4 kg
	Head + Stand	729.4 mm x 481 mm x 154.2 mm / 6.2 kg

43SE3B

LCD Panel	Pixel Pitch	0.4902 mm (H) X 0.4902 mm (V)
Power	Rated Voltage	AC 100-240 V~ 50/60 Hz 0.9 A
	Power Consumption	On Mode : 60 W Typ. Sleep Mode (RGB) : ≤ 0.7 W Sleep Mode (HDMI) : ≤ 0.7 W Off Mode : ≤ 0.5 W
Dimensions (Width x Height x Depth) / Weight	Head	969.6 mm x 563.9 mm x 38.6 mm / 9.8 kg
	Head + Stand	969.6 mm x 622.2 mm x 193 mm / 12.3 kg
	Head + Speaker	969.6 mm x 563.9 mm x 67.9 mm / 10.3 kg
	Head + Speaker + Stand	969.6 mm x 622.2 mm x 193 mm / 12.8 kg

43SE3KB

LCD Panel	Pixel Pitch	0.4902 mm (H) X 0.4902 mm (V)
Power	Rated Voltage	AC 100-240 V~ 50/60 Hz 0.9 A
	Power Consumption	On Mode : 60 W Typ. Sleep Mode (RGB) : ≤ 0.7 W Sleep Mode (HDMI) : ≤ 0.7 W Off Mode : ≤ 0.5 W
Dimensions (Width x Height x Depth) / Weight	Head	969.6 mm x 563.9 mm x 54.0 mm / 10 kg
	Head + Stand	969.6 mm x 622.2 mm x 193 mm / 12.5 kg

49SE3B

LCD Panel	Pixel Pitch	0.55926 mm (H) X 0.55926 mm (V)
Power	Rated Voltage	AC 100-240 V~ 50/60 Hz 1.0 A
	Power Consumption	On Mode : 65 W Typ. Sleep Mode (RGB) : ≤ 0.7 W Sleep Mode (HDMI) : ≤ 0.7 W Off Mode : ≤ 0.5 W
Dimensions (Width x Height x Depth) / Weight	Head	1102.2 mm x 638.5 mm x 38.6 mm / 14.1 kg
	Head + Stand	1102.2 mm x 696.8 mm x 219.6 mm / 17.4 kg
	Head + Speaker	1102.2 mm x 638.5 mm x 67.9 mm / 14.6 kg
	Head + Speaker + Stand	1102.2 mm x 696.8 mm x 219.6 mm / 17.9 kg

49SE3KB

LCD Panel	Pixel Pitch	0.55926 mm (H) X 0.55926 mm (V)
Power	Rated Voltage	AC 100-240 V~ 50/60 Hz 1.0 A
	Power Consumption	On Mode : 65 W Typ. Sleep Mode (RGB) : ≤ 0.7 W Sleep Mode (HDMI) : ≤ 0.7 W Off Mode : ≤ 0.5 W
Dimensions (Width x Height x Depth) / Weight	Head	1102.2 mm x 638.5 mm x 54.0 mm / 14.3 kg
	Head + Stand	1102.2 mm x 696.8 mm x 219.6 mm / 17.6 kg

55SE3B

LCD Panel	Pixel Pitch	0.630 mm (H) x 0.630 mm (V)
Power	Rated Voltage	AC 100-240 V~ 50/60 Hz 1.1 A
	Power Consumption	On Mode : 70 W Typ. Sleep Mode (RGB) : ≤ 0.7 W Sleep Mode (HDMI) : ≤ 0.7 W Off Mode : ≤ 0.5 W
Dimensions (Width x Height x Depth) / Weight	Head	1238 mm x 714.9 mm x 38.6 mm / 17.3 kg
	Head + Stand	1238 mm x 773.4 mm x 219.6 mm / 20.6 kg
	Head + Speaker	1238 mm x 714.9 mm x 67.9 mm / 17.8 kg
	Head + Speaker + Stand	1238 mm x 773.4 mm x 219.6 mm / 21.1 kg

55SE3KB

LCD Panel	Pixel Pitch	0.630 mm (H) x 0.630 mm (V)
Power	Rated Voltage	AC 100-240 V~ 50/60 Hz 1.1 A
	Power Consumption	On Mode : 70 W Typ. Sleep Mode (RGB) : ≤ 0.7 W Sleep Mode (HDMI) : ≤ 0.7 W Off Mode : ≤ 0.5 W
Dimensions (Width x Height x Depth) / Weight	Head	1238 mm x 714.9 mm x 54.0 mm / 17.5 kg
	Head + Stand	1238 mm x 773.4 mm x 219.6 mm / 20.8 kg

65SE3B

LCD Panel	Pixel Pitch	0.744 mm (H) x 0.744 mm (V)
Power	Rated Voltage	AC 100-240 V~ 50/60 Hz 1.4 A
	Power Consumption	On Mode : 95 W Typ. Sleep Mode (RGB) : ≤ 0.7 W Sleep Mode (HDMI) : ≤ 0.7 W Off Mode : ≤ 0.5 W
Dimensions (Width x Height x Depth) / Weight	Head	1456.9 mm x 838 mm x 41.1 mm / 27.7 kg
	Head + Stand	1456.9 mm x 898.1 mm x 293.7 mm / 32.9 kg
	Head + Speaker	1456.9 mm x 838 mm x 70.4 mm / 28.2 kg
	Head + Speaker + Stand	1456.9 mm x 898.1 mm x 293.7 mm / 33.4 kg

65SE3KB

LCD Panel	Pixel Pitch	0.744 mm (H) x 0.744 mm (V)
Power	Rated Voltage	AC 100-240 V~ 50/60 Hz 1.4 A
	Power Consumption	On Mode : 95 W Typ. Sleep Mode (RGB) : ≤ 0.7 W Sleep Mode (HDMI) : ≤ 0.7 W Off Mode : ≤ 0.5 W
Dimensions (Width x Height x Depth) / Weight	Head	1456.9 mm x 838 mm x 56.5 mm / 27.9 kg
	Head + Stand	1456.9 mm x 898.1 mm x 293.7 mm / 33.1 kg

Product Dimensions

The illustrations in this manual may differ from the actual product and accessories.

Please see **Mounting on a wall** section for screw sizes.

The product specifications below may be changed without prior notice due to upgrade of product functions.

32SE3*

(Unit: mm)

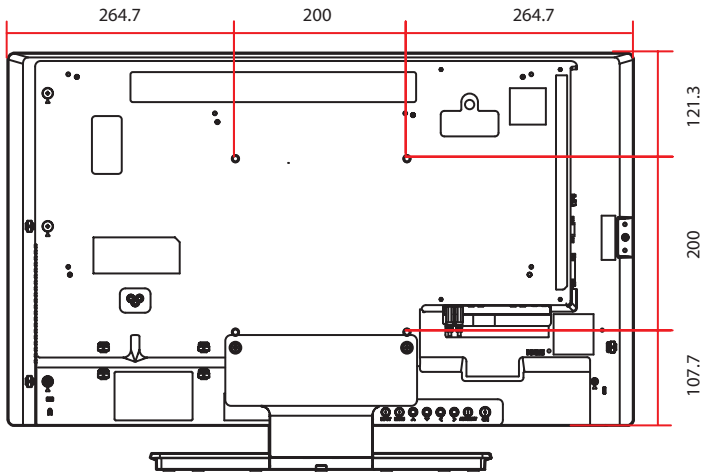
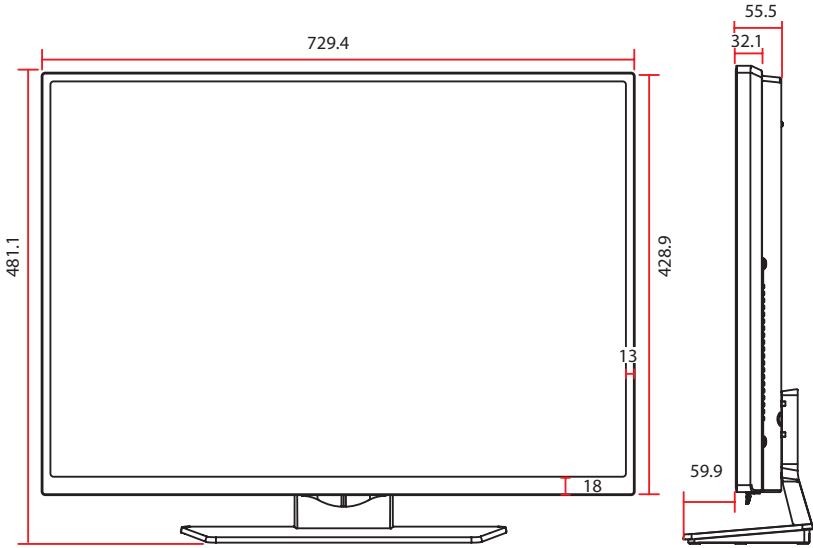

43SE3*

(Unit: mm)

ENGLISH

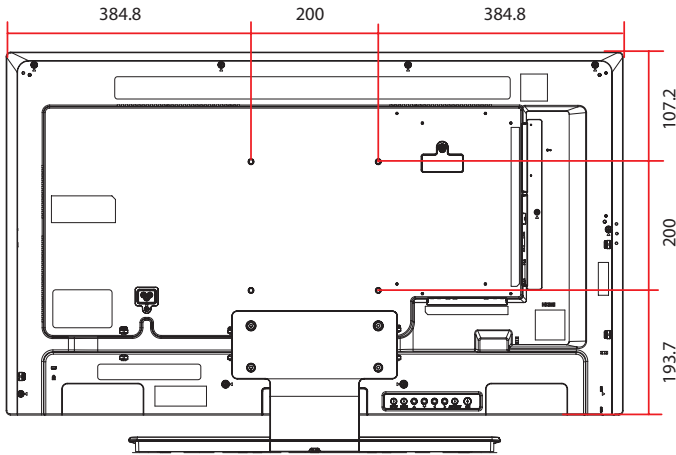
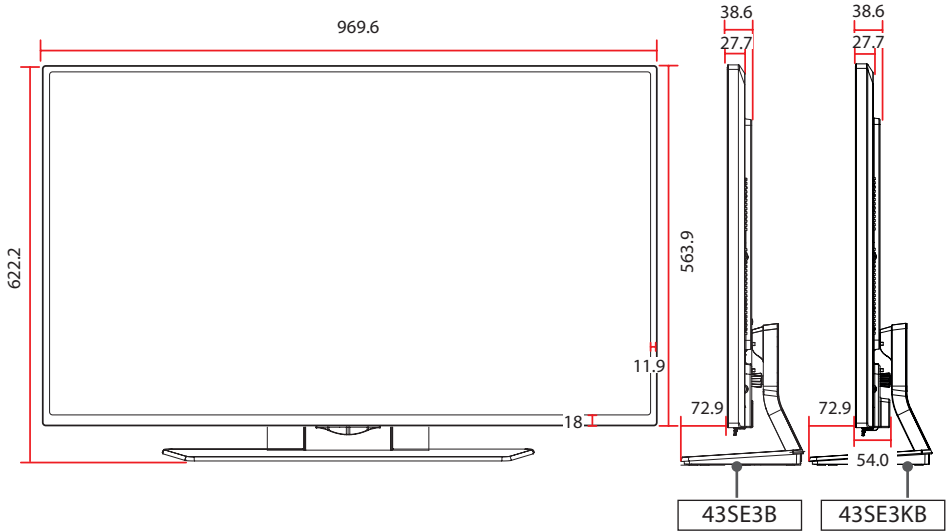

49SE3*

(Unit: mm)

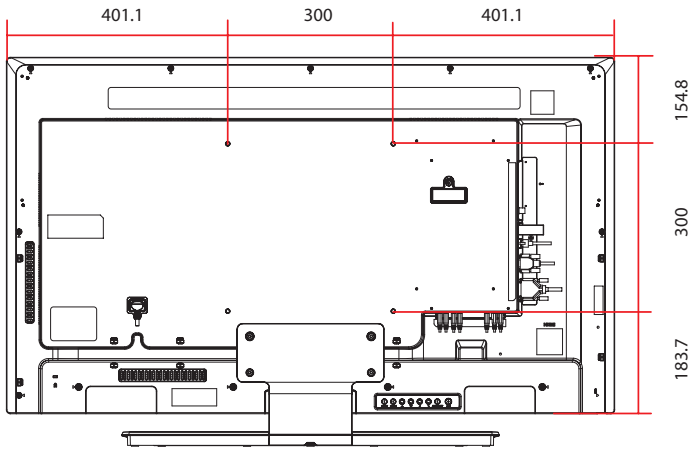
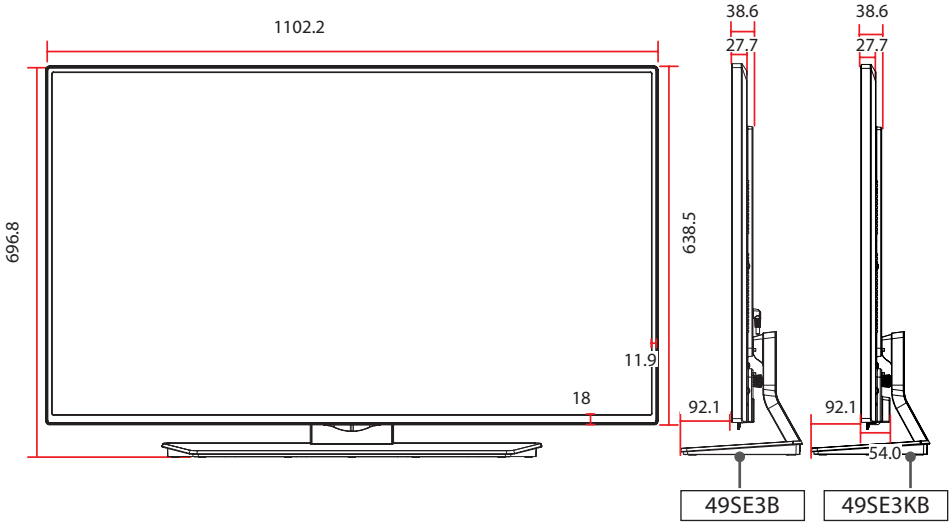

55SE3*

(Unit: mm)

ENGLISH

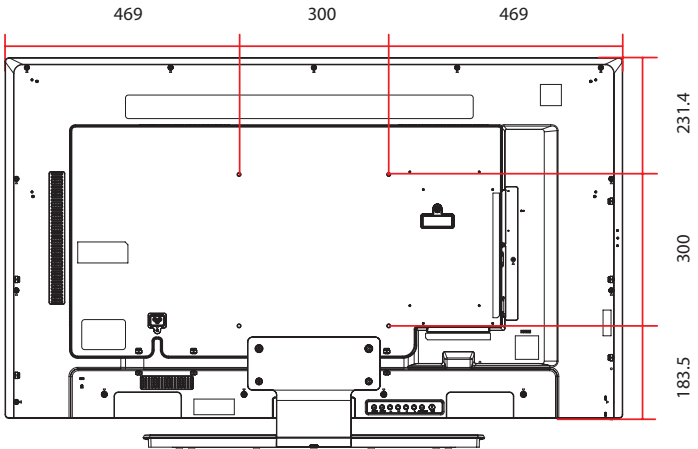
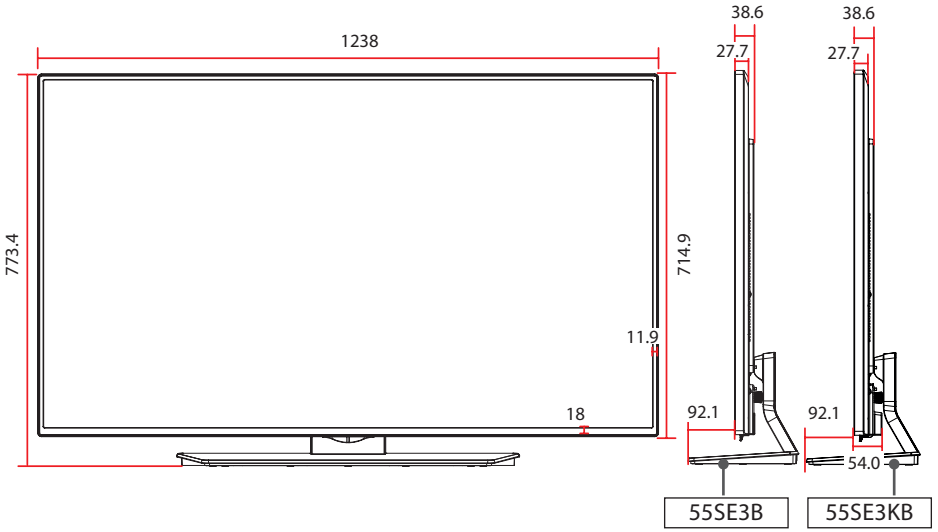

65SE3*

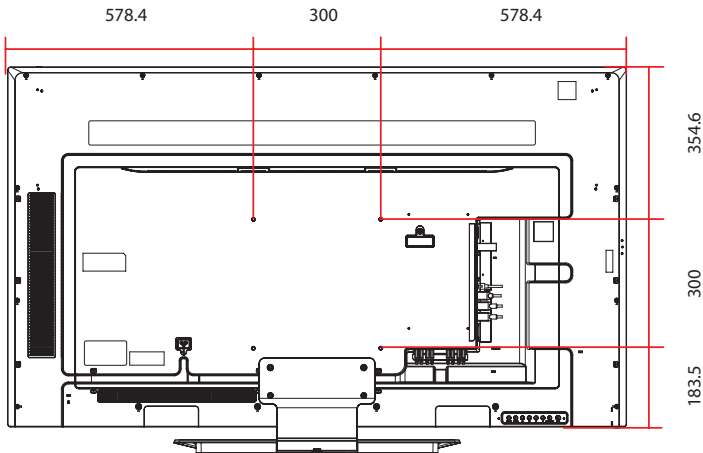
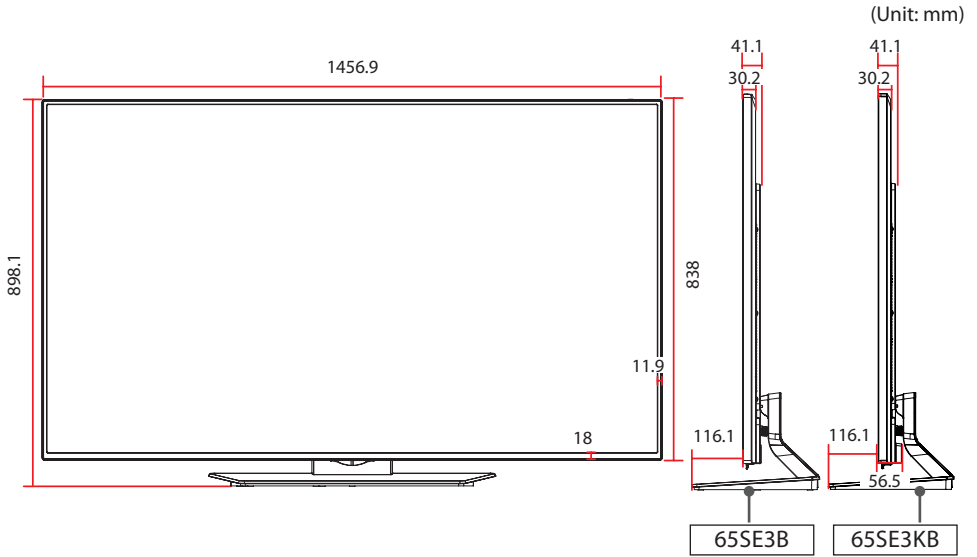

RGB (PC) supported mode

Resolution	Horizontal Frequency(kHz)	Vertical Frequency(Hz)
720 x 400	31.468	70.8
640 x 480	31.469	59.94
800 x 600	37.879	60.317
1024 x 768	48.363	60
1280 x 720	44.772	59.855
1280 x 960	60	60
1152 x 864	57.717	59.934
1280 x 1024	63.981	60.02
1920 x 1080	67.5	60

HDMI / DVI-D (DTV) supported mode

Resolution	Horizontal Frequency(kHz)	Vertical Frequency(Hz)
480/60P	31.5	60
576/50P	31.25	50
720/50P	37.5	50
720/60P	45	60
1080/50i	28.1	50
1080/60i	33.75	60
1080/50P	56.25	50
1080/60P	67.5	60

HDMI / DVI-D (PC) supported mode

Resolution	Horizontal Frequency(kHz)	Vertical Frequency(Hz)
640 x 480	31.469	59.94
800 x 600	37.879	60.317
1024 x 768	48.363	60
1280 x 720	44.772	59.855
1366 x 768	47.7	60
1280 x 1024	63.981	60.02
1680 x 1050	65.290	59.954
1920 x 1080	67.5	60

NOTE









- In the DVI-D or HDMI input, you can select the PC/DTV mode optionally. It is recommended that you select PC mode when connecting to a PC, and DTV mode when connecting to other devices.

NOTE

- PC resolutions available as the input label option in RGB and HDMI / DVI-D input modes : 640 x 480 / 60 Hz, 1280 x 720 / 60 Hz, 1920 x 1080 / 60 Hz and DTV resolutions : 480p, 720p, 1080p.
- Vertical frequency: To enable the user to watch the product display, screen image should be changed tens of times every second like a fluorescent lamp. The vertical frequency or refresh rate is the times of image display per second. The unit is Hz.
- Horizontal frequency: The horizontal interval is the time to display one vertical line. When 1 is divided by the horizontal interval, the number of horizontal lines displayed every second can be tabulated as the horizontal frequency. The unit is kHz.

IR CODES

- All models do not support the HDMI/USB function.
- Some key codes are not supported depending on the model.

Code (Hexa)	Function	Note
08	 Power	R/C BUTTON
0B	INPUT	R/C BUTTON
C4	MONITOR ON	R/C BUTTON
C5	MONITOR OFF	R/C BUTTON
95	ENERGY SAVING (e2)	R/C BUTTON
DC	3D	R/C BUTTON
10 to 19	Number Key 0 to 9	R/C BUTTON
53	1/a/A	R/C BUTTON
2F	CLEAR	R/C BUTTON
02	Volume  (+)	R/C BUTTON
03	Volume  (-)	R/C BUTTON
79	ARC	R/C BUTTON
99	AUTO	R/C BUTTON
09	MUTE	R/C BUTTON
E0	BRIGHTNESS ^ (Page UP)	R/C BUTTON
E1	BRIGHTNESS v (Page Down)	R/C BUTTON
4D	PSM	R/C BUTTON
AA	INFO 	R/C BUTTON
5F	W.BAL	R/C BUTTON
43	SETTINGS	R/C BUTTON
40	Up 	R/C BUTTON
41	Down 	R/C BUTTON
07	Left 	R/C BUTTON
06	Right 	R/C BUTTON
3F	S.MENU	R/C BUTTON
44	OK	R/C BUTTON
28	BACK	R/C BUTTON
5B	EXIT	R/C BUTTON
7E	 SIMPLINK	R/C BUTTON
7B	TILE (Tile Mode)	R/C BUTTON
B1		R/C BUTTON
B0		R/C BUTTON
BA		R/C BUTTON

Code (Hexa)	Function	Note
8F	◀	R/C BUTTON
8E	▶	R/C BUTTON
72	Red Key (PICTURE ID ON)	R/C BUTTON
71	Green Key (PICTURE ID OFF)	R/C BUTTON
63	Yellow Key	R/C BUTTON
61	Blue Key	R/C BUTTON

TO CONTROL MULTIPLE PRODUCTS

- Use this method to connect several products to a single PC. You can control several products at a time by connecting them to a single PC.
- In the Option menu, Set ID must be between 1 and 255 (or from 1 to 1,000) without being duplicated.

Connecting the Cable

Connect the RS-232C cable as shown in the picture.

- The RS-232C protocol is used for communication between the PC and product. You can turn the product on or off, select an input source or adjust the OSD menu from your PC.

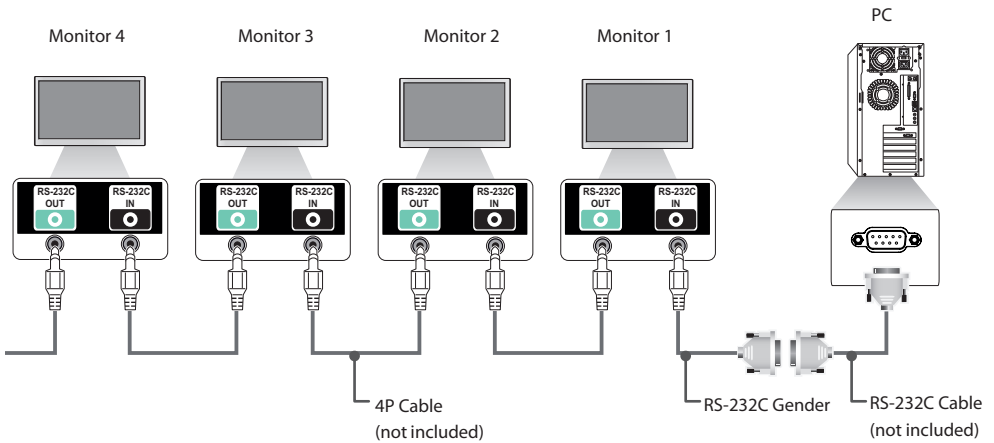

RS-232C Configurations

4P Cable

4-Wire Configurations (Standard RS-232C cable)



Communication Parameter

- **Baud Rate** 9600 BPS
- **Data Length** 8 bit
- **Parity Bit** None
- **Stop Bit** 1 bit
- **Flow Control** None
- **Communication Code** ASCII code
- Use a crossed (reverse) cable

! NOTE

- When using three-wire connections (non-standard), an IR daisy chain cannot be used.
- If you want to control multiple units simultaneously, use 3.5 mm 4-pole cables (sold separately).

RS-232C Cable

8-Wire Configurations (Standard RS-232C cable)

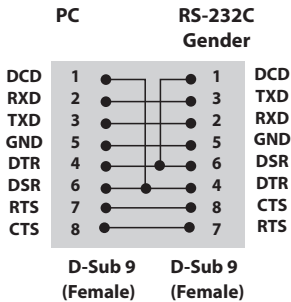

Command Reference List

		COMMAND		DATA (Hexadecimal)
		1	2	
01	Power	k	a	00 to 01
02	Select input	x	b	See [Select input]
03	Aspect ratio	k	c	See [Aspect ratio]
04	Energy saving	j	q	See [Energy saving]
05	Picture mode	d	x	See [Picture mode]
06	Contrast	k	g	00 to 64
07	Brightness	k	h	00 to 64
08	Sharpness	k	k	00 to 32
09	Color	k	i	00 to 64
10	Tint	k	j	00 to 64
11	Color temperature	x	u	00 to 64
12	H position	f	q	00 to 64
13	V position	f	r	00 to 64
14	H size	f	s	00 to 64
15	Auto Config.	j	u	01
16	Balance	k	t	00 to 64
17	Sound Mode	d	y	See [Sound mode]
18	Mute	k	e	00 to 01
19	Volume	k	f	00 to 64
20	Clock 1 (year/month/day)	f	a	See [Clock 1]
21	Clock 2 (hour/minute/second)	f	x	See [Clock 2]
22	Off time schedule	f	c	00 to 01
23	On time schedule	f	b	00 to 01
24	Off timer (repeat mode/time)	f	e	See [Off timer]
25	On timer (repeat mode/time)	f	d	See [On timer]
26	On timer input	f	u	See [On timer input]
27	Automatic Standby	m	n	00 to 01
28	Auto off	f	g	00 to 01
29	Language	f	i	See [Language]
30	Reset	f	k	00 to 02
31	Current temperature	d	n	FF
32	Key	m	c	See [Key]
33	Time elapsed	d	l	FF
34	Product serial number	f	y	FF

		COMMAND		DATA (Hexadecimal)
		1	2	
35	Software version	f	z	FF
36	White balance red gain	j	m	00 to FE
37	White balance green gain	j	n	00 to FE
38	White balance blue gain	j	o	00 to FE
39	Backlight	m	g	00 to 64
40	Screen off	k	d	00 to 01
41	Tile Mode	d	d	See [Tile Mode]
42	Tile Mode Check	d	z	FF
43	Tile ID	d	i	Refer to 'Tile ID'.
44	Tile H Position	d	e	00 to 32
45	Tile V Position	d	f	00 to 32
46	Tile H Size	d	g	00 to 32
47	Tile V Size	d	h	00 to 32
48	Natural Mode (In Tile mode)	d	j	00 to 01

 **NOTE**

- During USB operations such as Dvix or EMF, all commands except Power (k a) and Key (m c) are not executed and treated as NG.
- Some commands are not supported depending on the model.
- The 'ff' command which shows the status of a certain command does not display the OSD as the result in order to be compatible with SuperSign program.

Transmission / Receiving Protocol

Transmission

[Command1][Command2][][Set ID][][Data][Cr]

- * [Command1] Identifies the factory setting and the user setting modes.
- * [Command2] Controls monitors.
- * [Set ID] Used for selecting a set you want to control. A Set ID can be assigned to each set from 1 to 255 (from 01H to FFH), or from 1 to 1,000 (from 001H to 3e8H) in certain models, under OPTION in the OSD menu. Selecting '00H' or '000H' for Set ID allows the simultaneous control of all connected monitors. (It may not be supported depending on the model.)
- * [Data] Transmits command data.
Data count may increase depending on the command.
- * [Cr] Carriage Return. Corresponds to '0x0D' in ASCII code.
- * [] White Space. Corresponds to '0x20' in ASCII code.

Acknowledgement

[Command2][][Set ID][][OK/NG][Data][x]

- * The Product transmits an ACK (acknowledgement) based on this format when receiving normal data. At this time, if the data is FF, it indicates the present status data. If the data is in data write mode, it returns the data of the PC computer.
- * If a command is sent with Set ID '00' (=0x00) or '000' (=0x000), the data is reflected to all monitor sets and they do send any acknowledgement (ACK).
- * If the data value 'FF' is sent in control mode via RS-232C, the current setting value of a function can be checked (only for some functions).
- * Some commands may not be supported on some models.

01. Power (Command: k a)

Controls the power on/off of the set.

Transmission`[k][a][][Set ID][][Data][Cr]`

Data 00: Off
 01: On

Acknowledgement`[a][][Set ID][][OK/NG][Data][x]`

* Only when the monitor is fully powered on, the acknowledgement signal is returned properly.

* There may be a delay between the transmission and acknowledgement signals.

04. Energy saving (Command: j q)

Sets the energy saving function.

Transmission`[j][q][][Set ID][][Data][Cr]`

Data 00: Off
 01: Minimum
 02: Medium
 03: Maximum
 04: Automatic
 05: Screen off

Acknowledgement`[q][][Set ID][][OK/NG][Data][x]`

** This may not be supported on some models.

02. Select input (Command: x b)

Selects an input signal.

Transmission`[x][b][][Set ID][][Data][Cr]`

Data 60: RGB
 70: DVI-D (PC)
 80: DVI-D (DTV)
 90: HDMI (HDMI1) (DTV)
 A0: HDMI (HDMI1) (PC)

Acknowledgement`[b][][Set ID][][OK/NG][Data][x]`

* Some input signals may not be supported on some models.

05. Picture mode (Command: d x)

Selects a picture mode.

Transmission`[d][x][][Set ID][][Data][Cr]`

Data 00: Vivid
 01: Standard
 02: Cinema
 03: Sport
 04: Game
 05: Expert 1
 06: Expert 2
 08: Eco
 11 : Calibration

Acknowledgement`[x][][Set ID][][OK/NG][Data][x]`**03. Aspect ratio (Command: k c)**

Adjusts the aspect ratio.

Transmission`[k][c][][Set ID][][Data][Cr]`

Data 01: 4:3
 02: 16:9
 04: Zoom (HDMI)(DTV)
 06: Auto ratio (HDMI)(DTV)
 09: Original (≥ 720p) (HDMI) (DTV)
 10 to 1F: Cinema zoom 1 to 16 (HDMI) (DTV)

* Available data types differ depending on the input signal. For more information, see the aspect ratio section of the owner's manual.

* The aspect ratio may differ depending on the model's input configuration.

Acknowledgement`[c][][Set ID][][OK/NG][Data][x]`**06. Contrast (Command: k g)**

Adjusts the screen contrast.

Transmission`[k][g][][Set ID][][Data][Cr]`

Data 00 to 64: Contrast 0 to 100

Acknowledgement`[g][][Set ID][][OK/NG][Data][x]`

07. Brightness (Command: k h)

Adjusts the screen brightness.

Transmission

`[k][h][][Set ID][][Data][Cr]`

Data 00 to 64: Brightness 0 to 100

Acknowledgement

`[h][][Set ID][][OK/NG][Data][x]`**08. Sharpness (Command: k k)**

Adjusts the screen sharpness.

Transmission

`[k][k][][Set ID][][Data][Cr]`

Data 00 to 32: Sharpness 0 to 50

Acknowledgement

`[k][][Set ID][][OK/NG][Data][x]`**09. Color (Command: k i)**

Adjusts the screen color.

Transmission

`[k][i][][Set ID][][Data][Cr]`

Data 00 to 64: Color 0 to 100

Acknowledgement

`[i][][Set ID][][OK/NG][Data][x]`**10. Tint (Command: k j)**

Adjusts the screen tint.

Transmission

`[k][j][][Set ID][][Data][Cr]`

Data 00 to 64: Tint red 50 to green 50

Acknowledgement

`[j][][Set ID][][OK/NG][Data][x]`**11. Color temperature (Command: x u)**

Adjusts the screen color temperature.

Transmission

`[x][u][][Set ID][][Data][Cr]`

Data 00 to 64: Warm 50 to cool 50

Acknowledgement

`[u][][Set ID][][OK/NG][Data][x]`**12. H position (Command: f q)**

Adjusts the horizontal position of the screen.

This function is only available when the Tile Mode is set to Off.

* The operational range varies depending on the RGB input resolution.

(Only available in RGB-PC input mode)

Transmission

`[f][q][][Set ID][][Data][Cr]`

Data 00 to 64: Min -50 (left) to max 50 (right)

Acknowledgement

`[q][][Set ID][][OK/NG][Data][x]`

13. V position (Command: f r)

Adjusts the vertical position of the screen.
 This function is only available when the Tile Mode is set to Off.
 * The operational range varies depending on the RGB input resolution.
 (Only available in RGB-PC input mode)

Transmission

[f][r][][Set ID][][Data][Cr]

Data 00 to 64: Min -50 (down) to max 50 (up)

Acknowledgement

[r][][Set ID][][OK/NG][Data][x]

14. H size (Command: f s)

Adjusts the horizontal size of the screen.
 This function is only available when the Tile Mode is set to Off.
 * The operational range varies depending on the RGB input resolution.
 (Only available in RGB-PC input mode)

Transmission

[f][s][][Set ID][][Data][Cr]

Data 00 to 64: Min -50 (small) to max 50 (large)

Acknowledgement

[s][][Set ID][][OK/NG][Data][x]

15. Auto Config. (Command: j u)

Automatically corrects position and shaking of the picture.
 (Only available in RGB-PC input mode)

Transmission

[j][u][][Set ID][][Data][Cr]

Data 01: Execution

Acknowledgement

[u][][Set ID][][OK/NG][Data][x]

16. Balance (Command: k t)

Adjusts the sound balance.

Transmission

[k][t][][Set ID][][Data][Cr]

Data 00 to 64: Left 50 to right 50

Acknowledgement

[t][][Set ID][][OK/NG][Data][x]

17. Sound mode (Command: d y)

Selects a sound mode.

Transmission

[d][y][][Set ID][][Data][Cr]

Data 01: Standard
 02: Music
 03: Cinema
 04: Sport
 05: Game
 07: News

Acknowledgement

[y][][Set ID][][OK/NG][Data][x]

18. Mute (Command: k e)

Mutes/unmutes the sound.

Transmission

[k][e][][Set ID][][Data][Cr]

Data 00: Mute
 01: Unmute

Acknowledgement

[e][][Set ID][][OK/NG][Data][x]

19. Volume (Command: k f)

Adjusts the playback volume.

Transmission

[k][f][][Set ID][][Data][Cr]

Data 00 to 64: Volume 0 to 100

Acknowledgement

[f][][Set ID][][OK/NG][Data][x]

20. Clock 1 (year/month/day) (Command: f a)

Adjusts the Clock 1 (year/month/day) value.

Transmission

[f][a][][Set ID][][Data1][][Data2][][Data3][Cr]

Data1 00 to 14: Year 2010 to 2040

Data2 01 to 0C: January to December

Data3 01 to 1F: 1st to 31st

* Enter "fa [Set ID] ff" to view the Clock 1 (year/month/day) settings.

Acknowledgement

[a][][Set ID][][OK/NG][Data1][Data2][Data3][x]

21. Clock 2 (hour/minute/second) (Command: f x)

Adjusts the Clock 2 (hour/minute/second) value.

Transmission

[f][x][][Set ID][][Data1][][Data2][][Data3][Cr]

Data1 00 to 17: 00 to 23 hours

Data2 00 to 3B: 00 to 59 minutes

Data3 00 to 3B: 00 to 59 seconds

* Enter "fa [Set ID] ff" to view the Clock 2 (hour/minute/second) settings.

** This function is only available when Clock 1 (year/month/day) is set.

Acknowledgement

[x][][Set ID][][OK/NG][Data1][Data2][Data3][x]

22. Off time schedule (Command: f c)

Enables/disables the on time schedule.

Transmission

[f][c][][Set ID][][Data][Cr]

Data 00: Off
01: On

Acknowledgement

[c][][Set ID][][OK/NG][Data][x]

23. On time schedule (Command: f b)

Enables/disables the on time schedule.

Transmission

[f][b][][Set ID][][Data][Cr]

Data 00: Off
01: On

Acknowledgement

[b][][Set ID][][OK/NG][Data][x]

24. Off timer (repeat mode/time) (Command: f e)
Configures the off time (repeat mode/time) settings.

Transmission

[f][e][][Set ID][][Data1][][Data2][][Data3][Cr]

- Data1
1. F1 to F7 (reading data)
 - F1: Read the 1st off timer data
 - F2: Read the 2nd off timer data
 - F3: Read the 3rd off timer data
 - F4: Read the 4th off timer data
 - F5: Read the 5th off timer data
 - F6: Read the 6th off timer data
 - F7: Read the 7th off timer data
 2. E1 to E7 (deleting one index), E0 (deleting all indexes)
 - E0: Erase all off timer setting
 - E1: Erase the 1st off timer setting
 - E2: Erase the 2nd off timer setting
 - E3: Erase the 3rd off timer setting
 - E4: Erase the 4th off timer setting
 - E5: Erase the 5th off timer setting
 - E6: Erase the 6th off timer setting
 - E7: Erase the 7th off timer setting
 3. 01 to 0C (setting the day of the week for off timer)
 - 01: Once
 - 02: Daily
 - 03: Mon - Fri
 - 04: Mon - Sat
 - 05: Sat - Sun
 - 06: Every Sunday
 - 07: Every Monday
 - 08: Every Tuesday
 - 09: Every Wednesday
 - 0A: Every Thursday
 - 0B: Every Friday
 - 0C: Every Saturday
 - Data2 00 to 17: 00 to 23 hours
 - Data3 00 to 3B: 00 to 59 minutes
- * To read or delete the Off Time list, set FFH for [Data2] and [Data3].
- Example 1: fe 01 f1 ffff - Read the 1st index data from off timer.
Example 2: fe 01 e1 ffff - Delete the 1st index data from off timer.
Example 3: fe 01 04 02 03 - Sets Off Timer to 02:03 for Monday-Saturday.
- * This function is only available when Clock 1 (year/month/day) and Clock 2 (hour/minute/second) are set.

Acknowledgement

[e][][Set ID][][OK/NG][Data1][Data2][Data3][x]

25. On timer (repeat mode/time) (Command: f d)
Configures the on time (repeat mode/time) settings.

Transmission

[f][d][][Set ID][][Data1][][Data2][][Data3][Cr]

- Data1
1. F1 to F7 (reading data)
 - F1: Read the 1st on timer data
 - F2: Read the 2nd on timer data
 - F3: Read the 3rd on timer data
 - F4: Read the 4th on timer data
 - F5: Read the 5th on timer data
 - F6: Read the 6th on timer data
 - F7: Read the 7th on timer data
 2. E1 to E7 (deleting one index), E0 (deleting all indexes)
 - E0: Erase all on timer setting
 - E1: Erase the 1st on timer setting
 - E2: Erase the 2nd on timer setting
 - E3: Erase the 3rd on timer setting
 - E4: Erase the 4th on timer setting
 - E5: Erase the 5th on timer setting
 - E6: Erase the 6th on timer setting
 - E7: Erase the 7th on timer setting
 3. 01 to 0C (setting the day of the week for the on timer)
 - 01: Once
 - 02: Daily
 - 03: Mon - Fri
 - 04: Mon - Sat
 - 05: Sat - Sun
 - 06: Every Sunday
 - 07: Every Monday
 - 08: Every Tuesday
 - 09: Every Wednesday
 - 0A: Every Thursday
 - 0B: Every Friday
 - 0C: Every Saturday
 - Data2 00 to 17: 00 to 23 hours
 - Data3 00 to 3B: 00 to 59 minutes
- * To read or delete an on timer list you have set, [Data2][Data3] must be set to FFH.
- Example 1: fd 01 f1 ffff - Read the 1st index data from on timer.
Example 2: fd 01 e1 ffff - Delete the 1st index data from on timer.
Example 3: fd 01 04 02 03 - Set on timer at 02:03 on Monday to Saturday.
- * This function is only available when Clock 1 (year/month/day) and Clock 2 (hour/minute/second) are set.

Acknowledgement

[d][][Set ID][][OK/NG][Data1][Data2][Data3][x]

26. On timer input (Command: f u)

Adds a new schedule entry by selecting input for the current on timer setting.

Transmission

[f][u][][Set ID][][Data1][Cr]

[f][u][][Set ID][][Data1][Data2][Cr]

Data (adding schedule)

60: RGB

70: DVI-D

90: HDMI (HDMI1)

Data1

1: f1h to f7h (reading data)

F1: Select the 1st schedule input source

F2: Select the 2nd schedule input source

F3: Select the 3rd schedule input source

F4: Select the 4th schedule input source

F5: Select the 5th schedule input source

F6: Select the 6th schedule input source

F7: Select the 7th schedule input source

Data2

1: ffh (reading data)

To read the schedule input, enter FFH for [Data2].

If no schedule is available for [Data1] when attempting to read or change the schedule data, the text NG will be displayed and the operation will fail.

(Example 1: fu 01 60 - Move existing schedule entries down one row each and save RGB as input source for the 1st schedule entry.)

(Example 2: fu 01 f1 ff - Read the 1st schedule input data.)

* This function is only supported when 1 (year/month/date), 2 (hour/minute/second) and On Time (repeat mode/time) are set.

** Input may not be supported on some models.

Acknowledgement

[u][][Set ID][][OK/NG][Data][x]

[u][][Set ID][][OK/NG][Data1][Data2][x]

27. Automatic standby (Command: m n)

Configures the automatic standby settings.

Transmission

[m][n][][Set ID][][Data][Cr]

Data 00: Off (Will not turn off after 4/6/8 hours)

01: 4 hours (Off after 4 hours)

02: 6 hours (Off after 6 hours)

03: 8 hours (Off after 8 hours)

Acknowledgement

[n][][Set ID][][OK/NG][Data][x]

28. Auto off (Command: f g)

Configures the automatic off settings.

Transmission

[f][g][][Set ID][][Data][Cr]

Data 00: Off (Will not turn off after 15 minutes)

01: On (Off after 15 minutes)

Acknowledgement

[g][][Set ID][][OK/NG][Data][x]

29. Language (Command: f i)

Sets the OSD language.

Transmission

[f][i][][Set ID][][Data][Cr]

Data 00: Czech
01: Danish
02: German
03: English
04: Spanish (Europe)
05: Greek
06: French
07: Italian
08: Dutch
09: Norwegian
0A: Portuguese
0B: Portuguese (Brazil)
0C: Russian
0D: Finnish
0E: Swedish
0F: Korean
10: Chinese (Cantonese)
11: Japanese
12: Chinese (Mandarin)

Acknowledgement

[i][][Set ID][][OK/NG][Data][x]

30. Reset (Command: f k)

Resets settings for Picture, Screen and Audio or restores factory settings.

(Screen reset can only be performed in RGB input mode.)

Transmission

```
[f][k][ ][Set ID][ ][Data][Cr]
```

Data 00: Picture reset
 01: Screen reset
 02: Initial settings (factory reset)

Acknowledgement

```
[k][ ][Set ID][ ][OK/NG][Data][x]
```

31. Current temperature (Command: d n)

Checks the inside temperature value.

Transmission

```
[d][n][ ][Set ID][ ][Data][Cr]
```

Data FF: Check status

Acknowledgement

```
[n][ ][Set ID][ ][OK/NG][Data][x]
```

```
[n][ ][Set ID][ ][OK/NG][Data1][Data2][Data3][x]
```

* Temperature is displayed as a hexadecimal value.

32. Key (Command: m c)

Sends a key code for the IR remote control.

Transmission

```
[m][c][ ][Set ID][ ][Data][Cr]
```

Data IR_KEY_CODE

Acknowledgement

```
[c][ ][Set ID][ ][OK/NG][Data][x]
```

For key codes, see IR Codes.

* Some key codes may not be supported on some models.

33. Time elapsed (Command: d l)

Checks the elapsed time.

Transmission

```
[d][l][ ][Set ID][ ][Data][Cr]
```

Data FF: Read status

Acknowledgement

```
[l][ ][Set ID][ ][OK/NG][Data][x]
```

* The data received is shown as a hexadecimal value.

34. Product serial number (Command: f y)

Checks the serial number of the product.

Transmission

```
[f][y][ ][Set ID][ ][Data][Cr]
```

Data FF: Check product serial number

Acknowledgement

```
[y][ ][Set ID][ ][OK/NG][Data][x]
```

* Data is in ASCII code.

35. Software version (Command: f z)

Checks the software version of the product.

Transmission

```
[f][z][ ][Set ID][ ][Data][Cr]
```

Data FF: Check software version

Acknowledgement

```
[z][ ][Set ID][ ][OK/NG][Data][x]
```

36. White balance red gain (Command: j m)

Adjusts the white balance red gain value.

Transmission

[j][m][][Set ID][][Data][Cr]

Data 00 to FE: Red gain 0 to 254

Acknowledgement

[m][][Set ID][][OK/NG][Data][x]

37. White balance green gain (Command: j n)

Adjusts the white balance green gain value.

Transmission

[j][n][][Set ID][][Data][Cr]

Data 00 to FE: Green gain 0 to 254

Acknowledgement

[n][][Set ID][][OK/NG][Data][x]

38. White balance blue gain (Command: j o)

Adjusts the white balance blue gain value.

Transmission

[j][o][][Set ID][][Data][Cr]

Data 00 to FE: Blue gain 0 to 254

Acknowledgement

[o][][Set ID][][OK/NG][Data][x]

39. Backlight (Command: m g)

Adjusts the back light brightness.

Transmission

[m][g][][Set ID][][Data][Cr]

Data 00 to 64: Back light brightness 0 to 100

Acknowledgement

[g][][Set ID][][OK/NG][Data][x]

** This may not be supported on some models.

40. Screen off (Command: k d)

Turns the screen on or off.

Transmission

[k][d][][Set ID][][Data][Cr]

Data 00: Turns the screen on
01: Turns the screen off

Acknowledgement

[d][][Set ID][][OK/NG][Data][x]

41. Tile Mode (Command: d d)

To set a Tile Mode and Tile Column/ Row values.

Transmission

[d][d][][Set ID][][Data][Cr]

Data 00 to FF: 1st byte - Tile Row
2nd byte - Tile Column

*00, 01, 10, 11 means Tile Mode Off

** It may not be supported depending on the model.

Acknowledgement

[d][][Set ID][][OK/NG][Data][x]

42. Tile Mode Check (Command: d z)

To check Tile Mode status.

Transmission`[d][z][][Set ID][][Data][Cr]`

Data FF: Check Tile Mode status.

** It may not be supported depending on the model.

Acknowledgement`[z][][Set ID][][OK/NG][Data1][Data2][Data3][x]`

Data1 00: Tile Mode Off

01: Tile Mode On

Data2 00 to 0F: Tile Row

Data3 00 to 0F: Tile Column

43. Tile ID (Command: d i)

To set Tile ID.

Transmission`[d][i][][Set ID][][Data][Cr]`

Data 01 to E1: Tile ID 01 to 225**

FF: Check Tile ID

** Data could not be set over (Tile Column) x (Tile Row).

** It may not be supported depending on the model.

Acknowledgement`[i][][Set ID][][OK/NG][Data][x]`

*NG will be return if data is over (Tile Column) x (Tile Row), except 0xFF.

44. Tile H Position (Command: d e)

To adjust the Tile Horizontal position.

* This function is available only when the Natural option of the

Tile Mode is set to Off while the Tile Mode set to On.

Transmission`[d][e][][Set ID][][Data][Cr]`

Data 00 to 32: -50 (Left) to 0 (Right)

*Left/Right values depend on Tile H size.

** It may not be supported depending on the model.

Acknowledgement`[e][][Set ID][][OK/NG][Data][x]`**45. Tile V Position (Command: d f)**

To adjust the Tile Vertical position.

* This function is available only when the Natural option of the Tile Mode is set to Off while the Tile Mode set to On.

Transmission`[d][f][][Set ID][][Data][Cr]`

Data 0 to 32: 0 (Bottom) to 50 (Top)

* Bottom/Top values depend on Tile Vertical size.

** It may not be supported depending on the model.

Acknowledgement`[f][][Set ID][][OK/NG][Data][x]`**46. Tile H Size (Command: d g)**

To adjust the Tile Horizontal Size.

*Set Tile H Position to 0x32 before setting Tile H Size.

* This function is available only when the Natural option of the

Tile Mode is set to Off while the Tile Mode set to On.

Transmission`[d][g][][Set ID][][Data][Cr]`

Data 00 to 32: 0 to 50

** It may not be supported depending on the model.

Acknowledgement`[g][][Set ID][][OK/NG][Data][x]`**47. Tile V Size (Command: d h)**

To adjust the Tile Vertical size.

*Set Tile V Position to 0x00 before setting Tile V Size.

* This function is available only when the Natural option of the

Tile Mode is set to Off while the Tile Mode set to On.

Transmission`[d][h][][Set ID][][Data][Cr]`

Data 00 to 32: 0 to 50

** It may not be supported depending on the model.

Acknowledgement`[h][][Set ID][][OK/NG][Data][x]`

48. Natural Mode (In Tile Mode) (Command : d j)

To display the image naturally, the part of the image that would normally be displayed in the gap between the monitors is omitted.

Transmission

[d][j][][Set ID][][Data][Cr]

Data 00: Off
 01: On

Acknowledgement

[j][][Set ID][][OK/NG][Data][x]



! NOTE

- 65SE3B and 65SE3KB are not certified with EPA's ENERGY STAR.

ENERGY STAR is a set of power-saving guidelines issued by the U.S. Environmental Protection Agency(EPA).



As an ENERGY STAR Partner LGE U. S. A.,Inc. has determined that this product meets the ENERGY STAR guidelines for energy efficiency. Refer to ENERGYSTAR.gov for more information on the ENERGY STAR program.

Make sure to read the Safety Precautions before using the product.

The model and serial numbers of the SET are located on the back and one side of the SET. Record it below should you ever need service.

MODEL _____

SERIAL _____

To obtain the source code under GPL, LGPL, MPL, and other open source licenses, that is contained in this product, please visit <http://opensource.lge.com>.

In addition to the source code, all referred license terms, warranty disclaimers and copyright notices are available for download. LG Electronics will also provide open source code to you on CD-ROM for a charge covering the cost of performing such distribution (such as the cost of media, shipping, and handling) upon email request to opensource@lge.com. This offer is valid for three (3) years from the date on which you purchased the product.

WARNING -This is a class A product. In a domestic environment this product may cause radio interference, in which case the user may be required to take adequate measures.

Temporary noise is normal when powering ON or OFF this device.